

Valco valves

FOR INJECTION, SWITCHING, AND STREAM SELECTION

- 1/32", 1/16", 1/8", or 1/4" Valco ZDV fittings
- 3, 4, 6, 8, 10, 12, and 14 port and internal sample two position versions
- Five multiposition flowpath configurations with as many as 16 positions
- A variety of materials for hostile environments and continuous use at elevated temperature
- Can be configured for use at temperatures up to 350°C or pressures up to 5,000 psi

The Valco design lends itself to a unique variety of connecting slots and port arrangements. The rotor is held in place by a preload assembly, which allows rotor replacement without removing loops and tubing and without disengaging the valve from the actuator or mounting bracket.

In addition, the preload assembly ensures that the valve is always reassembled to the factory-set tension.

Two position injector and valve descriptions are on page 101; product numbers and prices begin on page 104. For information on **selectors**, refer to pages 102-3.

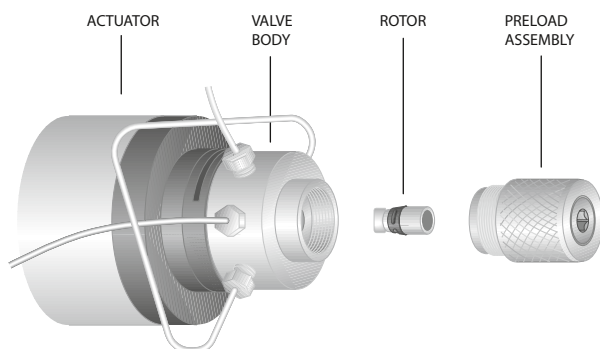

TECH TIP

For optimal zero dead volume connections, make sure your tubing meets the best industry standards. The OD tolerance should be nominal dimension $\pm .002$ ".

Fractional dimension	Nominal dimension
1/32"	.031
1/16"	.062
1/8"	.125
1/4"	.250
3/8"	.375
1/2"	.500

MORE INFORMATION

Decoding Valco valve product no's... 266-269

Valve descriptions

Chem inert injectors and valves... 146-151
Chem inert selectors .. 146, 152-153
Diaphragm... 142-143
Valco two position... 101
Valco selectors .. 102-103

Valco valve prices

GC 104-113
HPLC..... 114-118
Selector..... 124-135



The standard valve body material is Nitronic 60, a gall-resistant stainless steel which has proven superior to Type 316 or 303 in the majority of applications. Valves may also be ordered in Hastelloy C-22, Inconel 600, Type 316 stainless, Monel 400, Nickel 200, Nitronic 50, or Titanium.

Medium temperature GC valves have a rotor made of Valcon E, a polyaryletherketone/PTFE composite. The high temperature versions use a polyimide/PTFE/carbon composite designated Valcon T. Valcon H, a carbon-fiber-reinforced, PTFE-lubricated inert polymer, is standard in HPLC valves.

Appropriate fittings are supplied with all valves. Valves rated at 1000 psi or less have Type 303 stainless ferrules; those rated above 1000 psi have Type 316 stainless ferrules. A valve ordered with an optional body material is supplied with ferrules of the same material as the body, with Type 316 stainless nuts.

Specifying a Special Body Material

To specify a special valve body material, add the material code to the end of the valve product number. Contact the factory for the additional cost.

Example:

An A4C6WE (air actuated 1/16" 6 port WE valve with a 4" standoff) made of Hastelloy C-22 would be designated A4C6WEHC.

Due to design requirements, several special grades of stainless steel may be used where "HPLC grade" is noted. The specific types include Nitronic 60, Type 316 stainless steel, and Type 316L stainless steel. VICI will select the material to be used based on availability and quality. HPLC grade stainless is the standard material for all Valco two position valves and high pressure multiposition valves.

SPECIAL BODY MATERIAL — CODES

TWO POSITION VALVES

Body material	Code
HPLC grade Stainless steel	SS
Hastelloy C-22	HC
Inconel 600	IN
Monel 400	M4
Nickel	NI
Nitronic 50	N5
Titanium *	TI

MULTIPOSITION VALVES

Body material	Code
HPLC grade Stainless steel	SS
Hastelloy C-22	HC
Inconel 600	IN
Monel 400	M4
Nickel	NI
Nitronic 50	N5
Titanium *	TI

* Not available for WT, UWT, or T series valves (high temp) due to material temperature limit.

MORE INFORMATION

Materials

Metals pp 254-255
 Polymers 256
 Valve rotors 257

VALCO VALVES

Reliably Clean

All finished valve bodies are ultrasonically cleaned with water soluble detergents and then rinsed with hot deionized water. Finally they are given a thorough cleaning with steam from deionized water.

During valve assembly each part is cleaned with isopropanol and dried with filtered and dehumidified air. The valves are then heated and switched prior to being leak tested.

Precautions

After unpacking the valve, do not remove the protective tape from the valve ports until you are ready to install the valve. As supplied, all surfaces are clean and free of contaminants, and must be kept clean to prevent valve damage. Open ports and fittings cause unnecessary risk of particulate matter entering the valve and scratching the sealing surfaces, which is the most frequent cause of premature valve failure.

The most common source of contamination is particulates from tubing or unfiltered samples, or samples which leave a solid residue on drying (e.g. buffers).

Care should be taken that particles do not enter the valve.

TECH TIP

See **Technical Note 201, "Operation Notes and Cleaning Instructions"** for more detailed information about unpacking and handling the valve.

Leak Testing

The standard test methods for cross-port and outport leakage insure valve performance at pressures and temperatures up to the specifications listed. For valves used on mass spectrometers or for ultra-trace fixed gas analysis, we recommend an optional test method utilizing a helium mass spectrometer, which provides data on mechanical leaks and on those due to seal porosity and permeability. With this method, we can certify leak rates as low as 10^{-10} cc-atm/sec.

Please consult the factory prior to ordering, since the minimum leak rate will vary widely depending on valve configuration.

Leak Rates for Gas Sampling Valves

The actual minimum leak rates attainable vary widely with seal material and valve type. In general, the acceptable leak rates fall into three ranges. (See chart below.)

In order to seal to less than 10^{-7} , the valve loading tension is increased, which somewhat lowers the maximum operating temperature and the valve lifetime. Currently, only select material can seal to 10^{-8} in most valve styles. Valcon M rotor material can seal to 10^{-10} , but has a temperature limit of 50°C.

Not all valves can achieve these leak rates. As a general rule, the larger the valve seal and port size, the higher the leak rate.

Test Method for Liquid Sampling Valves

The standard test method for liquid valves is a pressure drop over time for both crossport and outport leakage, using isopropanol at the specified test pressure. This test is designed to ensure proper performance at the specification limit.

RANGES FOR ACCEPTABLE LEAK RATES

10^{-4} to 10^{-5} cc-atm/sec

Commercial use

Not normally sold by VICI

10^{-6} to 10^{-7} cc-atm/sec

General GC use

Standard tension and components

10^{-8} to 10^{-10} cc-atm/sec

Ultra trace gas analysis (ppb range)

Higher tension and specially processed stator and rotor material

OPTIONAL LEAK TESTING with Helium Mass Spectrometer

To order a valve certified to have helium leak rates less than 10^{-7} cc-atm/sec, add the suffix "Z" to the valve product number and contact the factory for the price.

Certified valves are supplied with gold-plated stainless steel ferrules.

We can generally tell you what leak rate is possible prior to manufacturing the valve.

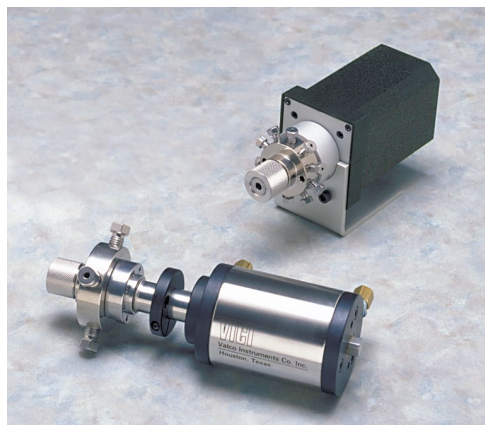

Two position injectors and switching valves have many applications, as shown in the section beginning on page 119. In this catalog, Valco two position valves are divided into GC and HPLC sections, with the GC section starting on page 104 and the HPLC section on page 114.

Sample Injectors

Since the most common method of sample injection utilizes a 6 port valve with an external sample loop, 6 port valves are often referred to as "injectors." However, as the Applications section shows, 6 port valves can do more than inject sample, and 8 and 10 port valves can be sample injectors at the same time they're also being backflushers or column switchers. One more variation is the 4 port internal sampling valve (*pages 104-5 and 114*), which is used when the sample size must be smaller than the smallest available loop. The internal sample "loop" is actually an engraved connecting slot on the rotor which is sized to contain a specified amount of sample.

Sample Loops

Loops are electrolytically cut and electrochemically polished to ensure square, burr-free ends, then cleaned with microfiltered steam from deionized water. Standard material is Type 316 stainless, but loops can be supplied in electroformed nickel, Hastelloy C, Nickel 200, titanium, or several polymers. Consult the factory for availability.

Valco sample loops are accurately sized for each valve type. However, with small volume loops, the tolerance on the ID of the tubing ($\pm 0.001"$) can have a significant effect on the volume. Therefore, loop volumes and loop appearance may differ from batch to batch.

SPECIFICATIONS

VALCO TWO POSITION VALVES

Valve type	Standard rotor material	Max pressure	Max temp	Max pressure	Max temp
			Internal sample injectors		
			Sampling and switching valves		
GC					
W and UW	Valcon E	1000 psi liq	175°C	400 psi gas	225°C
	Valcon T	–	–	300 psi gas	330°C
MW	Valcon E2	–	–	100 psi gas	75°C
HPLC					
W and UW	Valcon H	5000 psi liq	75°C	5000 psi liq	75°C

MORE INFORMATION

Actuation . . pp 188-209

Applications . 119-123

Materials

- Metals 254-255
- Polymers 256
- Valve rotors 257

Valve descriptions

- Cheminert injectors and valves 146-151
- Cheminert selectors . . 146, 152-153
- Diaphragm 142-153
- Valco selectors . . 102-103

Valco valve prices

- GC 104-113
- HPLC 114-118
- Selectors 124-135

VALVE TYPES

	Fitting size	Standard port diameter
W Type	1/32"	0.25 mm (.010")
	1/16"	0.40 mm (.016")
UW Type	1/16"	0.75 mm (.030")
	1/8"	0.75 mm (.030")
MW Type	1/4"	4.0 mm (.156")

For special port diameters, please consult the factory.

OPTIONAL ROTORS

Valcon M	400 psi	50°C
Valcon P	400 psi	175°C
Valcon R	400 psi	75°C
Valcon TF	200 psi	50°C

See page 257 for a discussion of these optional rotor materials.

VALCO VALVES

Instead of the back and forth switching of two position valves, selectors (multiposition valves) step incrementally through continuous revolutions (bi-directionally with universal and modular universal actuators). While we can supply older models, all the valves in this catalog have a preload assembly. This design allows the rotor to be inspected or replaced without taking the valve off the actuator, and valves ordered with a microelectric actuator are permanently aligned.

Flowpath Configurations

SD (dead-ended) valves select one of 4 to 16 dead-ended streams, directing it through the valve outlet to a sample valve, pressure sensor, detector, column, etc. The same configuration can also direct one stream to a number of outlets for fraction collection.

SC (common outlet) selectors are similar to SDs, except that instead of being dead-ended the non-selected streams flow to a common outlet.

SF (flow-through) selectors are similar to SDs and SCs, selecting a stream and sending it to the outlet. However, SFs allow the non-selected streams to flow through individual outlets instead of a common outlet.

ST (trapping) selectors are used for multi-column, multi-sample, or multi-trap operations.

STF (trapping/flow-through) selectors are similar to STs, with the single difference being that the non-selected streams are returned to their own vents or sources rather than being dead-ended or trapped as they are in the standard ST configuration.

PORT DIAMETERS—

Low pressure (MW)

Fitting size	No. of Positions	Standard port diameter
1/16"	4 - 16	0.75 mm (.030")
1/8"	4 - 16	1.0 mm (.040")
1/4"	4 - 10	4.0 mm (.156")

SD

1/16"	4 - 16	0.75 mm (.030")
1/8"	4 - 16	1.0 mm (.040")
1/4"	4 - 10	4.0 mm (.156")

SC

1/16"	4 - 16	1.0 mm (.040")
1/8"	4 - 16	1.0 mm (.040")
1/4"	4 - 8	4.0 mm (.156")

SF

1/16"	4 - 16	1.0 mm (.040")
1/8"	4 - 16	1.0 mm (.040")
1/4"	4 - 8	4.0 mm (.156")

ST

1/16"	4 - 16	0.75 mm (.030")
1/8"	4 - 16	1.0 mm (.040")

STF

1/16"	4 - 16	0.75 mm (.030")
1/8"	4 - 16	1.0 mm (.040")

PORT DIAMETERS—

High pressure (UW)

Fitting size	No. of Positions	Standard port diameter
--------------	------------------	------------------------

SD

1/16"	4 - 12	0.40 mm (.016")
1/8"	4, 6, 8	0.75 mm (.030")

ST

1/16"	4, 6	0.40 mm (.016")
-------	------	-----------------

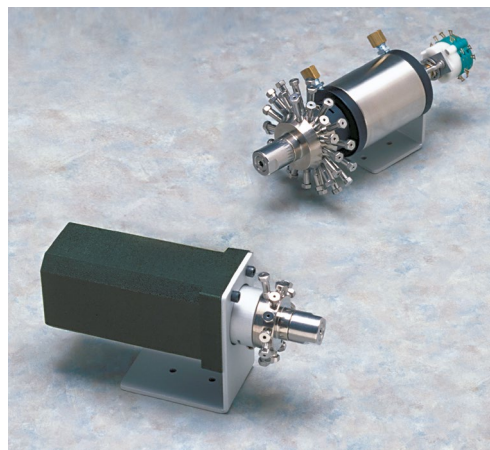

MORE INFORMATION

Actuation . . pp 188-209

Applications . . 119-123

Materials

Metals 254-255
 Polymers 256
 Valve rotors 257

Specifying a special body material 99

Selector prices

Low pressure

SD 124-125
 SC 126-127
 SF 128-129
 ST 130-131
 STF 132-133

High pressure

SD 134
 ST 135

Loops, if required, are found on corresponding valve pages.

For special port diameters, please consult the factory.

Low Pressure Selectors

Valco **MW Type** selectors are available with 1/16", 1/8", or 1/4" fittings. (For port diameters, refer to the chart on the preceding page.) The 1/16" and 1/8" selectors can be ordered with 4, 6, 8, 10, 12, or 16 positions, in any of the five flowpath configurations. Selectors with 1/4" fittings are available in SD, SC, and SF flowpaths: SDs have 4, 6, 8, or 10 positions; SCs and SFs have 4, 6, or 8.

Although not shown in this catalog, MW selectors are also available in a higher temperature version. While actual specifications vary with the configuration, typical specifications are 200 psi and 330°C. Consult our technical staff for more information.

SPECIFICATIONS

VALCO SELECTORS – Low pressure (MW)

Fittings size	Number of positions	Standard rotor material	Max pressure	Max temp	Max pressure	Max temp	Max pressure	Max temp
			SD Dead-end flowpath		SC Common outlet flowpath			
1/16"	4 - 16	Valcon E	400 psi gas	200°C	200 psi gas	200°C	Note: All low pressure 1/16" and 1/8" valves are also available in versions up to 330°C.	
1/8"	4 - 8	Valcon E	400 psi gas	200°C	200 psi gas	200°C		
	10 - 16	Valcon E	200 psi gas	200°C	200 psi gas	200°C		
1/4"	4 - 8	Valcon E2	100 psi gas	75°C	100 psi gas	75°C		
			SF Flow-through flowpath		ST Trapping flowpath		STF Trapping/Flow-through flowpath	
1/16"	4 - 16	Valcon E	200 psi gas	200°C	200 psi gas	200°C	200 psi gas	200°C
1/8"	4 - 16	Valcon E	200 psi gas	200°C	200 psi gas	200°C	200 psi gas	200°C
1/4"	4 - 8	Valcon E2	100 psi gas	75°C	–	–	–	–

High Pressure Selectors

Valco **UW Type** high pressure selectors are available in SD and ST flowpaths. SD selectors with 1/16" fittings are available in 4, 6, 8, 10, or 12 positions, while 1/8" selectors can be

ordered with 4, 6, 8, or 10 positions. ST flowpath UW selectors have 1/16" fittings, with either 4 or 6 positions. (For port diameters, refer to the chart on the preceding page.)

SPECIFICATIONS

VALCO SELECTORS – High pressure (UW)

Fittings size	Number of positions	Standard rotor material	Max pressure	Max temp	Max pressure	Max temp
			SD Dead-end flowpath		ST Trapping flowpath	
1/16"	4 - 12	Valcon E	5000 psi liq	75°C	5000 psi liq	75°C
1/8"	4 - 8	Valcon E	5000 psi liq	75°C	–	–

Internal sample injectors, 1/32" fittings, 0.25 mm ports (.010")

W Type

Med temp

Internal sample

1/32" 0.25 mm

Includes 2" standoff. Manual version is not available without standoff.
Microelectric actuator: 24 VDC, with 110/230 VAC to 24 VDC power supply



SPECS

1000 psi liq
175°C max

Nitronic 60 valve body
Valcon E rotor

OPTIONS

- 3", 4", and 6" standoffs
- Materials: Hastelloy C, Inconel 600, Monel 400, Nickel 200, Nitronic 50, Titanium, Zirconium (see pages 254-5)

Sample volume	.06 µl <i>Prod No</i>	.1 µl <i>Prod No</i>	.2 µl <i>Prod No</i>	.5 µl <i>Prod No</i>
Manual with standoff	2NI4WE.06	2NI4WE.1	2NI4WE.2	2NI4WE.5
With air actuator	A2NI4WE.06	A2NI4WE.1	A2NI4WE.2	A2NI4WE.5
With microelectric actuator	EP2NI4WE.06	EP2NI4WE.1	EP2NI4WE.2	EP2NI4WE.5
Replacement valve	DNI4WE.06	DNI4WE.1	DNI4WE.2	DNI4WE.5
Replacement rotor	SSANI4WE.06	SSANI4WE.1	SSANI4WE.2	SSANI4WE.5

Internal sample injectors, 1/16" fittings, 0.40 mm ports (.016")

W Type

Med temp

Internal sample

1/16" 0.40 mm

Includes 2" standoff. Manual version has no standoff.
Microelectric actuator: 24 VDC, with 110/230 VAC to 24 VDC power supply



SPECS

1000 psi liq
175°C max

Nitronic 60 valve body
Valcon E rotor

OPTIONS

- 6 and 8 port valves available
- 3", 4", and 6" standoffs
- Materials: Hastelloy C, Inconel 600, Monel 400, Nickel 200, Nitronic 50, Titanium, Zirconium (see pages 254-5)

Sample volume	.06 µl <i>Prod No</i>	.1 µl <i>Prod No</i>	.2 µl <i>Prod No</i>	.5 µl <i>Prod No</i>
Manual	CI4WE.06	CI4WE.1	CI4WE.2	CI4WE.5
Manual with standoff	2CI4WE.06	2CI4WE.1	2CI4WE.2	2CI4WE.5
With air actuator	A2CI4WE.06	A2CI4WE.1	A2CI4WE.2	A2CI4WE.5
With microelectric actuator	EP2CI4WE.06	EP2CI4WE.1	EP2CI4WE.2	EP2CI4WE.5
Replacement valve	DCI4WE.06	DCI4WE.1	DCI4WE.2	DCI4WE.5
Replacement rotor	SSACI4WE.06	SSACI4WE.1	SSACI4WE.2	SSACI4WE.5

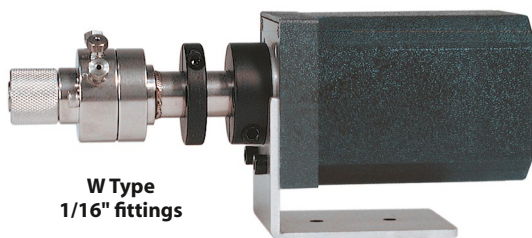

W Type
1/16" fittings

MORE INFORMATION

Actuators	
Air	page 197
Manual	204
Microelectric	190-1
Universal	193
Materials	
Metals	254-255
Polymers	256
Valve rotors	257
Standoff assemblies	205

Internal sample injectors, 1/16" fittings, 0.75 mm ports (.030")

UW Type

SPECS

1000 psi liq
175°C maxNitronic 60 valve body
Valcon E rotor

OPTIONS

- 6 and 8 port valves available
- 3", 4", and 6" standoffs
- Materials: Hastelloy C, Inconel 600, Monel 400, Nickel 200, Nitronic 50, Titanium, Zirconium (see pages 254-5)

Includes 2" standoff. Manual version has no standoff.
Microelectric actuator: 24 VDC, with 110/230 VAC to 24 VDC power supply



Med temp

Internal sample

1/16"

0.75 mm

Sample volume	.2 µl Prod No	.5 µl Prod No	1 µl Prod No	2 µl Prod No
Manual	CI4UWE.2	CI4UWE.5	CI4UWE1	CI4UWE2
Manual with standoff	2CI4UWE.2	2CI4UWE.5	2CI4UWE1	2CI4UWE2
With air actuator	A2CI4UWE.2	A2CI4UWE.5	A2CI4UWE1	A2CI4UWE2
With microelectric actuator	ED2CI4UWE.2	ED2CI4UWE.5	ED2CI4UWE1	ED2CI4UWE2
Replacement valve	DCI4UWE.2	DCI4UWE.5	DCI4UWE1	DCI4UWE2
Replacement rotor	SSACI4UWE.2	SSACI4UWE.5	SSACI4UWE1	SSACI4UWE2

Internal sample injectors, 1/8" fittings, 0.75 mm ports (.030")

UW Type

SPECS

1000 psi liq
175°C maxNitronic 60 valve body
Valcon E rotor

OPTIONS

- 3", 4", and 6" standoffs
- Materials: Hastelloy C, Inconel 600, Monel 400, Nickel 200, Nitronic 50, Titanium, Zirconium (see pages 254-5)

Includes 2" standoff. Manual version has no standoff.
Microelectric actuator: 24 VDC, with 110/230 VAC to 24 VDC power supply



Med temp

Internal sample

1/8"

0.75 mm

Sample volume	.2 µl Prod No	.5 µl Prod No	1 µl Prod No	2 µl Prod No
Manual	I4UWE.2	I4UWE.5	I4UWE1	I4UWE2
Manual with standoff	2I4UWE.2	2I4UWE.5	2I4UWE1	2I4UWE2
With air actuator	A2I4UWE.2	A2I4UWE.5	A2I4UWE1	A2I4UWE2
With microelectric actuator	ED2I4UWE.2	ED2I4UWE.5	ED2I4UWE1	ED2I4UWE2
Replacement valve	DI4UWE.2	DI4UWE.5	DI4UWE1	DI4UWE2
Replacement rotor	SSAI4UWE.2	SSAI4UWE.5	SSAI4UWE1	SSAI4UWE2

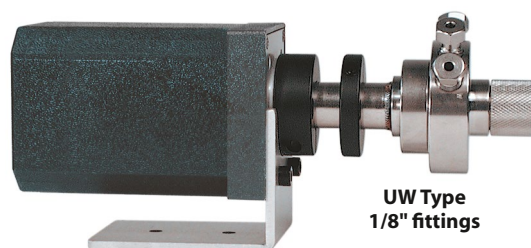
UW Type
1/8" fittings

Sampling and switching valves, 1/32" fittings, 0.25 mm ports (.010")

W Type

Med temp

1/32" 0.25 mm

Includes 4" standoff. Manual version not available without standoff.
 Microelectric actuator: 24 VDC, with 110/230 VAC to 24 VDC power supply
 Sample loops are not included with valves. Order separately.

SPECS

400 psi gas
225°C max
 Nitronic 60 valve body
 Valcon E rotor

For 300 psi, 350°C max,
 see facing page.

OPTIONS

- 3 and 12 port valves available
- 2", 3", and 6" standoffs
- Materials: Hastelloy C, Inconel 600, Monel 400, Nickel 200, Nitronic 50, Titanium, Zirconium (see pages 254-5)



4 Ports
Prod No



6 Ports
Prod No



8 Ports
Prod No



10 Ports
Prod No

Manual with standoff	4N4WE	4N6WE	4N8WE	4N10WE
With air actuator	A4N4WE	A4N6WE	A4N8WE	A4N10WE
With microelectric actuator	EH4N4WE	EH4N6WE	EH4N8WE	EH4N10WE
Replacement valve	DN4WE	DN6WE	DN8WE	DN10WE
Replacement rotor	SSAN4WE	SSAN6WE	SSAN8WE	SSAN10WE

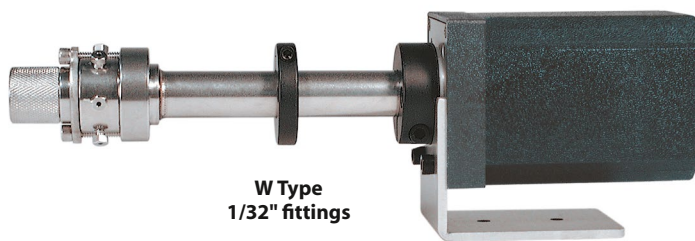

W Type
 1/32" fittings

1/32" Stainless steel loops *for W Type valves*

Each stainless steel loop includes two stainless nuts and two stainless ferrules. Order special fittings separately.



<i>Volume</i>	<i>Prod No</i>	<i>Volume</i>	<i>Prod No</i>
2 µl	SL2NW	25 µl	SL25NW
5 µl	SL5NW	50 µl	SL50NW
10 µl	SL10NW	100 µl	SL100NW
15 µl	SL15NW	250 µl	SL250NW
20 µl	SL20NW	500 µl	SL500NW

ABOUT LOOPS

- Other materials available in many sizes: Electroformed Nickel, Nickel 200, PEEK, and PTFE
- Sample loop shape and dimensions may vary from batch to batch due to fluctuations in tubing ID. Loop volume is controlled as closely as possible, but is not calibrated.

MORE INFORMATION

Actuators
 Air page 197
 Manual.....204
 Microelectric 190-1
 Universal 193
 Materials
 Metals..... 254-255
 Polymers256
 Valve rotors.....257
 Standoff assemblies205

Sampling and switching valves, 1/32" fittings, 0.25 mm ports (.010")

W Type

SPECS

300 psi gas
350°C max
 Nitronic 60 valve body
 Valcon T rotor

For 400 psi, 225°C max,
 see facing page

OPTIONS

- 3 and 12 port valves available
- 2", 3", and 6" standoffs
- Materials: Hastelloy C, Inconel 600, Monel 400, Nickel 200, Nitronic 50, Titanium, Zirconium (see pages 254-5)

Includes 4" standoff. Manual version not available without standoff.
 Microelectric actuator: 24 VDC, with 110/230 VAC to 24 VDC power supply
 Sample loops are not included with valves. Order separately.

High temp
1/32" 0.25 mm



4 Ports
Prod No



6 Ports
Prod No



8 Ports
Prod No



10 Ports
Prod No

Manual with standoff	4N4WT	4N6WT	4N8WT	4N10WT
With air actuator	A4N4WT	A4N6WT	A4N8WT	A4N10WT
With microelectric actuator	EH4N4WT	EH4N6WT	EH4N8WT	EH4N10WT
Replacement valve	DN4WT	DN6WT	DN8WT	DN10WT
Replacement rotor	SSAN4WT	SSAN6WT	SSAN8WT	SSAN10WT

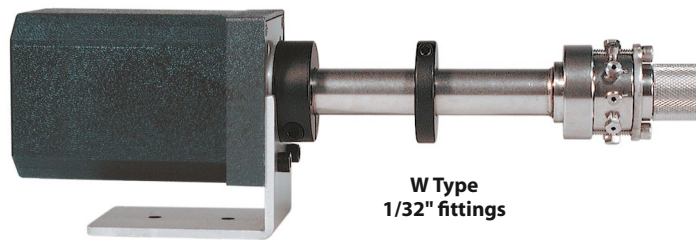

W Type
1/32" fittings

ABOUT LOOPS

- Other materials available in many sizes: Electroformed Nickel, Nickel 200, PEEK, and PTFE
- Sample loop shape and dimensions may vary from batch to batch due to fluctuations in tubing ID. Loop volume is controlled as closely as possible, but is not calibrated.

1/32" Stainless steel loops

for W Type valves

Each stainless steel loop includes two stainless nuts and two stainless ferrules. Order special fittings separately.



Volume	Prod No	Volume	Prod No
2 µl	SL2NW	25 µl	SL25NW
5 µl	SL5NW	50 µl	SL50NW
10 µl	SL10NW	100 µl	SL100NW
15 µl	SL15NW	250 µl	SL250NW
20 µl	SL20NW	500 µl	SL500NW

Sampling and switching valves, 1/16" fittings, 0.40 mm (.016")

*W*Type

Med temp
1/16" 0.40 mm

Includes 4" standoff Manual version has no standoff
 Microelectric actuator: 24 VDC, with 110/230 VAC to 24 VDC power supply
 Sample loops are not included with valves. Order separately.

SPECS

400 psi gas
225°C max
 Nitronic 60 valve body
 Valcon E rotor

For 300 psi, 350°C max, see page 110.

OPTIONS

- 3 and 12 port valves available
- 2", 3", and 6" standoffs
- Materials: Hastelloy C, Inconel 600, Monel 400, Nickel 200, Nitronic 50, Titanium, Zirconium (see pages 254-5)
- Smaller and larger bores available in most configurations.



4 Ports
Prod No



6 Ports
Prod No



8 Ports
Prod No



10 Ports
Prod No

Manual	C4WE	C6WE	C8WE	C10WE
Manual with standoff	4C4WE	4C6WE	4C8WE	4C10WE
With air actuator	A4C4WE	A4C6WE	A4C8WE	A4C10WE
With microelectric actuator	EH4C4WE	EH4C6WE	EH4C8WE	EH4C10WE
Replacement valve	DC4WE	DC6WE	DC8WE	DC10WE
Replacement rotor	SSAC4WE	SSAC6WE	SSAC8WE	SSAC10WE

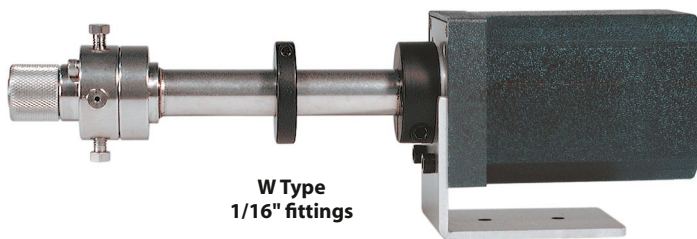

W Type
1/16" fittings

1/16" Stainless steel loops

for W Type valves

Each stainless steel loop includes two stainless nuts and two stainless ferrules. Order special fittings separately.



<i>Volume</i>	<i>Prod No</i>	<i>Volume</i>	<i>Prod No</i>
2 µl	SL2CW	100 µl	SL100CW
5 µl	SL5CW	250 µl	SL250CW
10 µl	SL10CW	500 µl	SL500CW
15 µl	SL15CW	1 ml	SL1KCW
20 µl	SL20CW	2 ml	SL2KCW
25 µl	SL25CW	5 ml	SL5KCW
50 µl	SL50CW	10 ml	SL10KCW

ABOUT LOOPS

- Other materials available in many sizes: Electroformed Nickel, Hastelloy C, Nickel 200, PEEK, PTFE, and Titanium
- Loops > 2 ml are made from 1/8" OD tubing with brazed or welded 1/16" tube ends or reducing unions.
- Sample loop shape and dimensions may vary from batch to batch due to fluctuations in tubing ID. Loop volume is controlled as closely as possible, but is not calibrated.

MORE INFORMATION

Actuators
 Air page 197
 Manual.....204
 Microelectric 190-1
 Universal 193
 Materials
 Metals..... 254-25 5
 Polymers 256
 Valve rotors.....257
 Standoff assemblies205

Sampling and switching valves, 1/16" fittings, 0.75 mm ports (.030")

UW Type

SPECS

400 psi gas
225°C max

Nitronic 60 valve body
Valcon E rotor

For 300 psi, 330°C max,
see page 111.

OPTIONS

- 3, 12 and 14 port valves available
- 2", 3", and 6" standoffs
- Materials: Hastelloy C, Inconel 600, Monel 400, Nickel 200, Nitronic 50, Titanium, Zirconium (see pages 254-5)
- Larger bore available

Includes 4" standoff. Manual version has no standoff.

Microelectric actuator: 24 VDC, with 110/230 VAC to 24 VDC power supply

Sample loops are not included with valves. Order separately.

Med temp

1/16" 0.75 mm



4 Ports
Prod No



6 Ports
Prod No



8 Ports
Prod No



10 Ports
Prod No

Manual	C4UWE	C6UWE	C8UWE	C10UWE
Manual with standoff	4C4UWE	4C6UWE	4C8UWE	4C10UWE
With air actuator	A4C4UWE	A4C6UWE	A4C8UWE	A4C10UWE
With microelectric actuator	ED4C4UWE	ED4C6UWE	ED4C8UWE	ED4C10UWE
Replacement valve	DC4UWE	DC6UWE	DC8UWE	DC10UWE
Replacement rotor	SSAC4UWE	SSAC6UWE	SSAC8UWE	SSAC10UWE

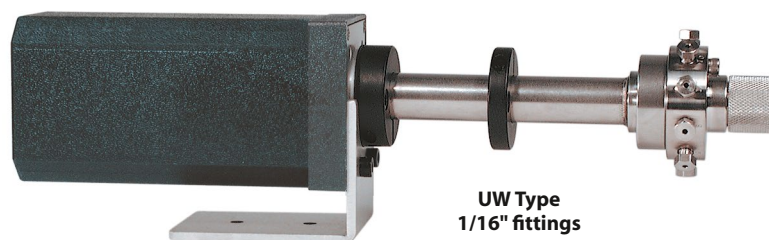

UW Type
1/16" fittings

ABOUT LOOPS

- Other materials available in many sizes: Electroformed Nickel, Hastelloy C, Nickel 200, PEEK, PTFE, and Titanium
- Loops > 2 ml are made from 1/8" OD tubing with brazed or welded 1/16" tube ends or reducing unions.
- Sample loop shape and dimensions may vary from batch to batch due to fluctuations in tubing ID. Loop volume is controlled as closely as possible, but is not calibrated.

1/16" Stainless steel loops

for UW Type valves

Each stainless steel loop includes two stainless nuts and two stainless ferrules. Order special fittings separately.



Volume	Prod No	Volume	Prod No
5 µl	SL5CUW	100 µl	SL100CUW
10 µl	SL10CUW	250 µl	SL250CUW
15 µl	SL15CUW	500 µl	SL500CUW
20 µl	SL20CUW	1 ml	SL1KCUW
25 µl	SL25CUW	2 ml	SL2KCUW
50 µl	SL50CUW	5 ml	SL5KCUW
		10 ml	SL10KCUW

VALCO VALVES

Sampling and switching valves, 1/16" fittings, 0.40 mm ports (.016")

W Type

High temp

1/16" 0.40 mm

Includes 4" standoff
 Microelectric actuator: 24 VDC, with 110/230 VAC to 24 VDC power supply
 Sample loops are not included with valves. Order separately.

SPECS

300 psi gas
 350°C max

Nitronic 60 valve body
 Valcon T rotor

For 400 psi, 225°C max,
 see page 108.

OPTIONS

- 3 and 12 port valves available
 UW type: 3, 12, and 14 port valves available
- 2", 3", and 6" standoffs
- Materials: Hastelloy C, Inconel 600, Monel 400, Nickel 200, Nitronic 50, Titanium, Zirconium (see pages 254-5)
- Smaller and larger bores available in most configurations.



4 Ports
 Prod No



6 Ports
 Prod No



8 Ports
 Prod No



10 Ports
 Prod No

Manual with standoff	4C4WT	4C6WT	4C8WT	4C10WT
With air actuator	A4C4WT	A4C6WT	A4C8WT	A4C10WT
With microelectric actuator	EH4C4WT	EH4C6WT	EH4C8WT	EH4C10WT
Replacement valve	DC4WT	DC6WT	DC8WT	DC10WT
Replacement rotor	SSAC4WT	SSAC6WT	SSAC8WT	SSAC10WT

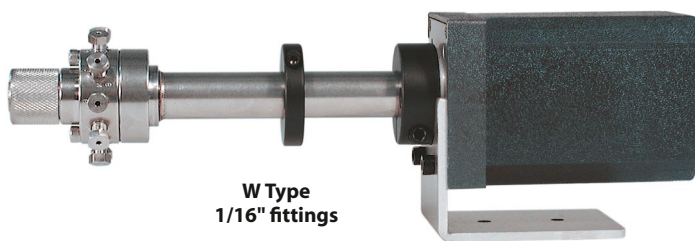

W Type
 1/16" fittings

1/16" Stainless steel loops

for W Type valves

Each stainless steel loop includes two stainless nuts and two stainless ferrules. Order special fittings separately.



Volume	Prod No	Volume	Prod No
2 µl	SL2CW	100 µl	SL100CW
5 µl	SL5CW	250 µl	SL250CW
10 µl	SL10CW	500 µl	SL500CW
15 µl	SL15CW	1 ml	SL1KCW
20 µl	SL20CW	2 ml	SL2KCW
25 µl	SL25CW	5 ml	SL5KCW
50 µl	SL50CW	10 ml	SL10KCW

ABOUT LOOPS

- Other materials available in many sizes: Electroformed Nickel, Hastelloy C, Nickel 200, PEEK, PTFE, and Titanium
- Loops > 2 ml are made from 1/8" OD tubing with brazed or welded 1/16" tube ends or reducing unions.
- Sample loop shape and dimensions may vary from batch to batch due to fluctuations in tubing ID. Loop volume is controlled as closely as possible, but is not calibrated.

MORE INFORMATION

Actuators
 Air page 197
 Manual 204
 Microelectric 190-1
 Universal 193
 Materials
 Metals 254-255
 Polymers 256
 Valve rotors 257
 Standoff assemblies 205

Sampling and switching valves, 1/16" fittings, 0.75 mm ports (.030")

UW Type

SPECS

300 psi gas
330°C max
 Nitronic 60 valve body
 Valcon T rotor

For 400 psi, 225°C max,
 see page 109.

OPTIONS

- 3, 12 and 14 port valves available
- 2", 3", and 6" standoffs
- Materials: Hastelloy C, Inconel 600, Monel 400, Nickel 200, Nitronic 50, Titanium, Zirconium (see pages 254-5)
- Larger bore available

Includes 4" standoff
 Microelectric actuator: 24 VDC, with 110/230 VAC to 24 VDC power supply
 Sample loops are not included with valves. Order separately.

High temp
1/16" 0.75 mm



4 Ports
Prod No



6 Ports
Prod No



8 Ports
Prod No



10 Ports
Prod No

Manual with standoff	4C4UWT	4C6UWT	4C8UWT	4C10UWT
With air actuator	A4C4UWT	A4C6UWT	A4C8UWT	A4C10UWT
With microelectric actuator	ED4C4UWT	ED4C6UWT	ED4C8UWT	ED4C10UWT
Replacement valve	DC4UWT	DC6UWT	DC8UWT	DC10UWT
Replacement rotor	SSAC4UWT	SSAC6UWT	SSAC8UWT	SSAC10UWT

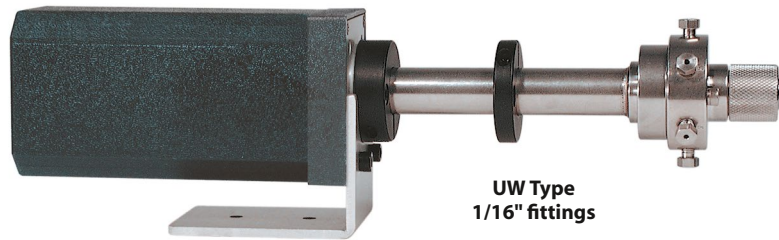

UW Type
1/16" fittings

ABOUT LOOPS

- Other materials available in many sizes: Electroformed Nickel, Hastelloy C, Nickel 200, PEEK, PTFE, and Titanium
- Loops > 2 ml are made from 1/8" OD tubing with brazed or welded 1/16" tube ends or reducing unions.
- Sample loop shape and dimensions may vary from batch to batch due to fluctuations in tubing ID. Loop volume is controlled as closely as possible, but is not calibrated.

1/16" Stainless steel loops *for UW Type valves*

Each stainless steel loop includes two stainless nuts and two stainless ferrules. Order special fittings separately.

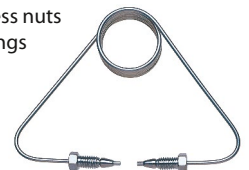

Volume	Prod No	Volume	Prod No
5 µl	SL5CUW	100 µl	SL100CUW
10 µl	SL10CUW	250 µl	SL250CUW
15 µl	SL15CUW	500 µl	SL500CUW
20 µl	SL20CUW	1 ml	SL1KCUW
25 µl	SL25CUW	2 ml	SL2KCUW
50 µl	SL50CUW	5 ml	SL5KCUW
		10 ml	SL10KCUW

Sampling and switching valves, 1/8" fittings, 0.75 mm ports (.030")

UWType

Med temp

Includes 4" standoff. Manual version has no standoff.

Microelectric actuator: 24 VDC, with 110/230 VAC to 24 VDC power supply

Sample loops are not included with valves. Order separately (see facing page).

SPECS





400 psi gas
225°C max

Nitronic 60 valve body
Valcon E rotor

For 300 psi, 330°C max,
see facing page.

OPTIONS

- 3, 12, and 14 port valves available
- 2", 3", and 6" standoffs
- Materials: Hastelloy C, Inconel 600, Monel 400, Nickel 200, Nitronic 50, Titanium, Zirconium (see pages 254-5)
- Larger bore available

	1/8"	0.75 mm				
						
			4 Ports Prod No	6 Ports Prod No	8 Ports Prod No	10 Ports Prod No
Manual			4UWE	6UWE	8UWE	n/a
Manual with standoff			44UWE	46UWE	48UWE	410UWE
With air actuator			A44UWE	A46UWE	A48UWE	A410UWE
With microelectric actuator			ED44UWE	ED46UWE	ED48UWE	ED410UWE
Replacement valve			D4UWE	D6UWE	D8UWE	D10UWE
Replacement rotor			SSA4UWE	SSA6UWE	SSA8UWE	SSA10UWE

Sampling and switching valves, 1/4" fittings, 4.0 mm ports (.156")

MWType

Low temp

Includes 4" standoff. Manual version not available without standoff.

Microelectric actuator: 24 VDC, with 110/230 VAC to 24 VDC power supply

Sample loops are not available.



SPECS

100 psi gas
75°C max

Nitronic 60 valve body
Valcon E2 rotor

OPTIONS

- 2", 3", and 6" standoffs
- Materials: Hastelloy C, Inconel 600, Monel 400, Nickel 200, Nitronic 50, Titanium, Zirconium (see pages 254-5)

	1/4"	4.0 mm			
					
			4 Ports Prod No	6 Ports Prod No	8 Ports Prod No
Manual with standoff			4VL4MWE2	4VL6MWE2	4VL8MWE2
With air actuator			A4VL4MWE2	A4VL6MWE2	A4VL8MWE2
With microelectric actuator			ET4VL4MWE2	ET4VL6MWE2	ET4VL8MWE2
Replacement valve			DVL4MWE2	DVL6MWE2	DVL8MWE2
Replacement rotor			SSAVL4MWE2	SSAVL6MWE2	SSAVL8MWE2

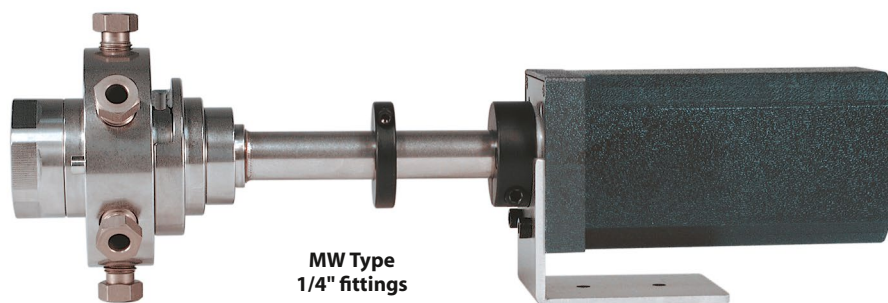

MW Type
1/4" fittings

Sampling and switching valves, 1/8" fittings, 0.75 mm ports (.030")

UW Type

SPECS

300 psi gas
330°C max
 Nitronic 60 valve body
 Valcon T rotor





For 400 psi, 225°C max,
 see facing page.

OPTIONS

- 3, 12, and 14 port valves available
- 2", 3", and 6" standoffs
- Materials: Hastelloy C, Inconel 600, Monel 400, Nickel 200, Nitronic 50, Titanium, Zirconium (see pages 254-5)
- Larger bore available

Includes 4" standoff. Manual version not available without standoff.
 Microelectric actuator: 24 VDC, with 110/230 VAC to 24 VDC power supply
 Sample loops are not included with valves. Order separately.

High temp
1/8" 0.75 mm

	 4 Ports <i>Prod No</i>	 6 Ports <i>Prod No</i>	 8 Ports <i>Prod No</i>	 10 Ports <i>Prod No</i>
Manual with standoff	44UWT	46UWT	48UWT	410UWT
With air actuator	A44UWT	A46UWT	A48UWT	A410UWT
With microelectric actuator	ED44UWT	ED46UWT	ED48UWT	ED410UWT
Replacement valve	D4UWT	D6UWT	D8UWT	D10UWT
Replacement rotor	SSA4UWT	SSA6UWT	SSA8UWT	SSA10UWT

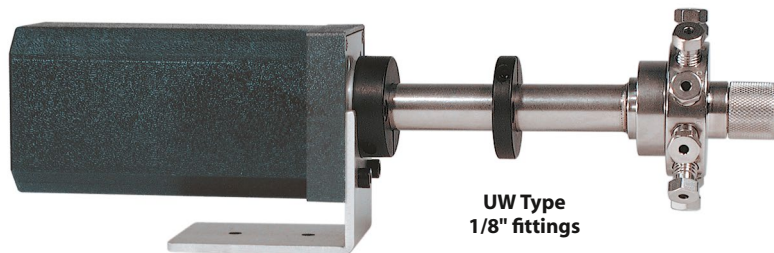

ABOUT LOOPS

- Other materials available in many sizes: Electroformed Nickel, Hastelloy C, Nickel 200, PEEK, PTFE, and Titanium
- Loops <100 µl are made from 1/16" OD tubing with brazed or welded 1/8" tube ends.
- Sample loop shape and dimensions may vary from batch to batch due to fluctuations in tubing ID. Loop volume is controlled as closely as possible, but is not calibrated.

MORE INFORMATION

Actuators
 Air page 197
 Manual 204
 Microelectric 190-1
 Universal 193

Materials
 Metals 254-255
 Polymers 256
 Valve rotors 257

Standoff assemblies 205

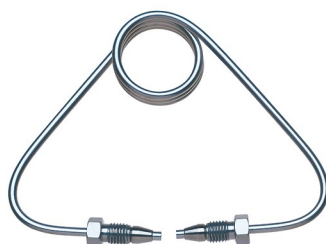

1/8" Stainless steel loops for UW Type valves

Each stainless steel loop includes two stainless nuts and two stainless ferrules. Order special fittings separately.

Volume	Prod No	Volume	Prod No
10 µl	SL10UW	250 µl	SL250UW
15 µl	SL15UW	500 µl	SL500UW
20 µl	SL20UW	1 ml	SL1KUW
25 µl	SL25UW	2 ml	SL2KUW
50 µl	SL50UW	5 ml	SL5KUW
100 µl	SL100UW	10 ml	SL10KUW
		20 ml	SL20KUW

VALCO VALVES

Internal sample injectors, 1/16" fittings, 0.40 mm ports (.016")
0.25 mm column port diameter (.010")

W Type

5,000 psi
Internal sample
1/16" 0.40 mm

Microelectric actuator: 24 VDC, with 110/230 VAC to 24 VDC power supply



Sample volume	.06 µl <i>Prod No</i>	.1 µl <i>Prod No</i>	.2 µl <i>Prod No</i>	.5 µl <i>Prod No</i>
Manual	CI4W.06	CI4W.1	CI4W.2	CI4W.5
With air actuator	ACI4W.06	ACI4W.1	ACI4W.2	ACI4W.5
With microelectric actuator	EPCI4W.06	EPCI4W.1	EPCI4W.2	EPCI4W.5
Replacement valve	DCI4W.06	DCI4W.1	DCI4W.2	DCI4W.5
Replacement rotor	SSACI4W.06	SSACI4W.1	SSACI4W.2	SSACI4W.5

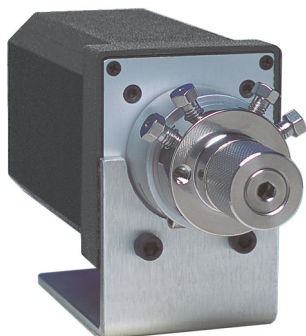

W Type
1/16" fittings

SPECS

5000 psi liq
75°C max
 Nitronic 60 valve body
 Valcon H rotor

OPTIONS

- 2", 3", 4", and 6" standoffs
- Materials: Hastelloy C, Inconel 600, Monel 400, Nickel 200, Nitronic 50, Titanium, Zirconium (see pages 254-5)
- 1/32" fittings with 0.25 mm bore (.010") also available. Consult factory for product number and pricing.

Internal sample injectors, 1/16" fittings, 0.75 mm ports (.030")

UW Type

5,000 psi
Internal sample
1/16" 0.75 mm

Microelectric actuator: 24 VDC, with 110/230 VAC to 24 VDC power supply



Sample volume	.2 µl <i>Prod No</i>	.5 µl <i>Prod No</i>	1 µl <i>Prod No</i>	2 µl <i>Prod No</i>
Manual with 2" standoff	2CI4UW.2	2CI4UW.5	2CI4UW1	2CI4UW2
With air actuator	ACI4UW.2	ACI4UW.5	ACI4UW1	ACI4UW2
With microelectric actuator	EDCI4UW.2	EDCI4UW.5	EDCI4UW1	EDCI4UW2
Replacement valve	DCI4UW.2	DCI4UW.5	DCI4UW1	DCI4UW2
Replacement rotor	SSACI4UW.2	SSACI4UW.5	SSACI4UW1	SSACI4UW2



UW Type
1/16" fittings

SPECS

5000 psi liq
75°C max
 Nitronic 60 valve body
 Valcon H rotor

OPTIONS

- 2", 3", 4", and 6" standoffs
- Materials: Hastelloy C, Inconel 600, Monel 400, Nickel 200, Nitronic 50, Titanium, Zirconium (see pages 254-5)
- 1/32" fittings with 0.25 mm bore (.010") also available. Consult factory for product number and pricing.

NOTE

These valves are not available in manual closemount version.

Injectors and switching valves, 1/16" fittings, 0.40 mm ports (.016")

W Type

SPECS





5000 psi liq
75°C max
 Nitronic 60 valve body
 Valcon H rotor

OPTIONS

- 3 and 12 port valves available
- 2", 3", 4", and 6" standoffs
- 1/32" and 1/16" versions available with 0.25 mm (.010") bore
- Materials: Hastelloy C, Inconel 600, Monel 400, Nickel 200, Nitronic 50, Titanium, Zirconium (see pages 254-5)

Microelectric actuator: 24 VDC, with 110/230 VAC to 24 VDC power supply
 Sample loops are not included with valves. Order separately.

5,000 psi	
Analytical	
1/16"	0.40 mm

				
	4 Ports <i>Prod No</i>	6 Ports <i>Prod No</i>	8 Ports <i>Prod No</i>	10 Ports <i>Prod No</i>
Manual	C4W	C6W	C8W	C10W
With air actuator	AC4W	AC6W	AC8W	AC10W
With microelectric actuator	EPC4W	EPC6W	EPC8W	EPC10W
Replacement valve	DC4W	DC6W	DC8W	DC10W
Replacement rotor	SSAC4W	SSAC6W	SSAC8W	SSAC10W



W Type
1/16" fittings

OPTIONAL FLOWPATH

Model C6W 6 port valves can also be ordered with a dual 3-way rotor, as described in EPA Method 555.

To specify this flowpath, substitute "2X3" for "6" in the valve or rotor product number.



MORE INFORMATION

Actuators

Air	page 197
Manual	204
Microelectric	190-1
Universal	193

Materials

Metals	254-255
Polymers	256
Valve rotors	257

Standoff assemblies205

ABOUT LOOPS

- Other materials available in many sizes: Electroformed Nickel, Hastelloy C, Nickel 200, PEEK, PTFE, and Titanium
- Loops > 2 ml are made from 1/8" OD tubing with brazed or welded 1/16" tube ends or reducing unions.
- Sample loop shape and dimensions may vary from batch to batch due to fluctuations in tubing ID. Loop volume is controlled as closely as possible, but is not calibrated.

1/16" Stainless steel loops

for W Type valves

Each stainless steel loop includes two stainless nuts and two stainless ferrules. Order special fittings separately.



<i>Volume</i>	<i>Prod No</i>	<i>Volume</i>	<i>Prod No</i>
2 µl	SL2CW	100 µl	SL100CW
5 µl	SL5CW	250 µl	SL250CW
10 µl	SL10CW	500 µl	SL500CW
15 µl	SL15CW	1 ml	SL1KCW
20 µl	SL20CW	2 ml	SL2KCW
25 µl	SL25CW	5 ml	SL5KCW
50 µl	SL50CW	10 ml	SL10KCW

VALCO VALVES

Injectors and switching valves, 1/16" fittings, 0.75 mm ports (.030")

UW Type

- 5,000 psi**
- Semi-prep**
- 1/16"**
0.75 mm

Microelectric actuator: 24 VDC, with 110/230 VAC to 24 VDC power supply
 Sample loops are not included with valves. Order separately.

SPECS

**5000 psi liq
 75°C max**

Nitronic 60 valve body
 Valcon H rotor

OPTIONS

- 3, 12, and 14 port valves available
- 2", 3", 4", and 6" standoffs
- 1/32" and 1/16" versions available with 0.25 mm (.010") bore
- Materials: Hastelloy C, Inconel 600, Monel 400, Nickel 200, Nitronic 50, Titanium, Zirconium (see pages 254-5)
- Larger bore available.

NOTE

These valves are not available in manual closemount version.



4 Ports
Prod No



6 Ports
Prod No



8 Ports
Prod No



10 Ports
Prod No

Manual with 2" standoff
 With air actuator
 With microelectric actuator

 Replacement valve
 Replacement rotor

2C4UW
 AC4UW
 EDC4UW

 DC4UW
 SSAC4UW

2C6UW
 AC6UW
 EDC6UW

 DC6UW
 SSAC6UW

2C8UW
 AC8UW
 EDC8UW

 DC8UW
 SSAC8UW

2C10UW
 AC10UW
 EDC10UW

 DC10UW
 SSAC10UW

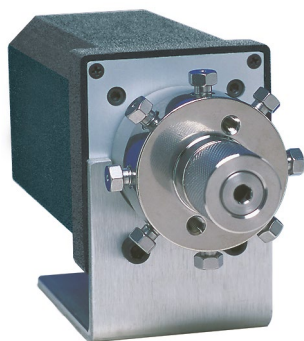

UW Type
1/16" fittings

1/16" Stainless steel loops

for UW Type valves

Each stainless steel loop includes two stainless nuts and two stainless ferrules.
 Order special fittings separately.



Volume	Prod No	Volume	Prod No
3 µl	SL3CUW	100 µl	SL100CUW
5 µl	SL5CUW	250 µl	SL250CUW
10 µl	SL10CUW	500 µl	SL500CUW
15 µl	SL15CUW	1 ml	SL1KCUW
20 µl	SL20CUW	2 ml	SL2KCUW
25 µl	SL25CUW	5 ml	SL5KCUW
50 µl	SL50CUW	10 ml	SL10KCUW

ABOUT LOOPS

- Other materials available in many sizes: Electroformed Nickel, Hastelloy C, Nickel 200, PEEK, PTFE, and Titanium
- Loops > 2 ml are made from 1/8" OD tubing with brazed or welded 1/16" tube ends or reducing unions.
- Sample loop shape and dimensions may vary from batch to batch due to fluctuations in tubing ID. Loop volume is controlled as closely as possible, but is not calibrated.

Injectors and switching valves, 1/8" fittings, 0.75 mm (.030")

UW Type

SPECS

5000 psi liq
75°C max
 Nitronic 60 valve body
 Valcon H rotor

OPTIONS

- 3 and 12 port valves available
- 2", 3", 4", and 6" standoffs
- Materials: Hastelloy C, Inconel 600, Monel 400, Nickel 200, Nitronic 50, Titanium, Zirconium (see pages 254-5)
- Larger bore available. (see page 118)

NOTE





These valves are not available in manual closemount version.

Manual 10 port includes 2" standoff.
 Microelectric actuator: 24 VDC, with 110/230 VAC to 24 VDC power supply
 Sample loops are not included with valves. Order separately.

5,000 psi

Semi-prep

1/8" 0.75 mm

				
	4 Ports <i>Prod No</i>	6 Ports <i>Prod No</i>	8 Ports <i>Prod No</i>	10 Ports <i>Prod No</i>
Manual with 2" standoff	24UW	26UW	28UW	210UW
With air actuator	A4UW	A6UW	A8UW	A10UW
With microelectric actuator	ED4UW	ED6UW	ED8UW	ED10UW
Replacement valve	D4UW	D6UW	D8UW	D10UW
Replacement rotor	SSA4UW	SSA6UW	SSA8UW	SSA10UW

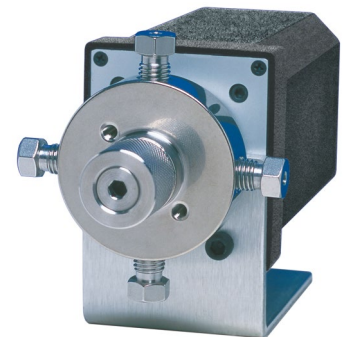

UW Type
1/8" fittings

ABOUT LOOPS

- Other materials available in many sizes: Electroformed Nickel, Hastelloy C, Nickel 200, PEEK, PTFE, and Titanium
- Loops < 100 µl are made from 1/16" OD tubing with brazed or welded 1/8" tube ends.
- Sample loop shape and dimensions may vary from batch to batch due to fluctuations in tubing ID. Loop volume is controlled as closely as possible, but is not calibrated.

MORE INFORMATION

Actuators

Air page 197

Manual 204

Microelectric 190-1

Universal 193

Materials

Metals 254-255

Polymers 256

Valve rotors 257

Standoff assemblies 205

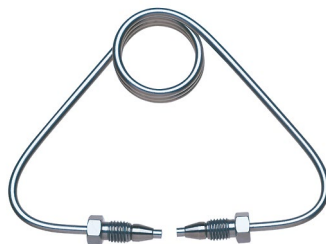

1/8" Stainless steel loops for UW Type valves

Each stainless steel loop includes two stainless nuts and two stainless ferrules. Order special fittings separately.

Volume	Prod No	Volume	Prod No
10 µl	SL10UW	250 µl	SL250UW
15 µl	SL15UW	500 µl	SL500UW
20 µl	SL20UW	1 ml	SL1KUW
25 µl	SL25UW	2 ml	SL2KUW
50 µl	SL50UW	5 ml	SL5KUW
100 µl	SL100UW	10 ml	SL10KUW
		20 ml	SL20KUW

VALCO VALVES

Injectors and switching valves, 1/8" fittings, large bore

UW Type

5,000 psi

Prep

1/8" Large bore

Manual 10 port includes 2" standoff.
 Microelectric actuator: 24 VDC, with 110/230 VAC to 24 VDC power supply.
 Sample loops are not included with valves. Order separately.

SPECS

5000 psi liq
 75°C max

Nitronic 60 valve body
 Valcon H rotor

OPTIONS

- 3 port valve available
- 2", 3", 4", and 6" standoffs
- Materials: Hastelloy C, Inconel 600, Monel 400, Nickel 200, Nitronic 50, Titanium, Zirconium (see pages 254-5)
- Smaller bore available. (see page 117)

NOTE

These valves are not available in manual closemount version.



4 Ports
 1.7 mm (.067")
 Prod No



6 Ports
 1.7 mm (.067")
 Prod No



8 Ports
 1.3 mm (.050")
 Prod No



10 Ports
 1.0 mm (.040")
 Prod No

Manual with 2" standoff
 With air actuator
 With microelectric actuator

2L4UW
 AL4UW
 EDL4UW

2L6UW
 AL6UW
 EDL6UW

2L8UW
 AL8UW
 EDL8UW

2L10UW
 AL10UW
 EDL10UW

Replacement valve
 Replacement rotor

DL4UW
 SSAL4UW

DL6UW
 SSAL6UW

DL8UW
 SSAL8UW

DL10UW
 SSAL10UW

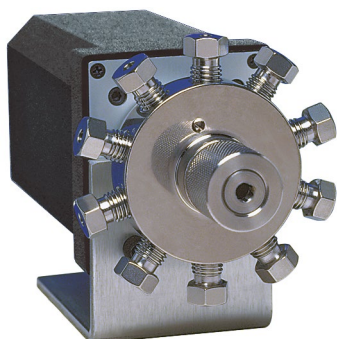

UW Type
 1/8" fittings

1/8" Stainless steel loops for UW Type valves

Each stainless steel loop includes two stainless nuts and two stainless ferrules. Order special fittings separately.

Volume	Prod No	Volume	Prod No
100 µl	SL100UW	2 ml	SL2KUW
250 µl	SL250UW	5 ml	SL5KUW
500 µl	SL500UW	10 ml	SL10KUW
1 ml	SL1KUW	20 ml	SL20KUW

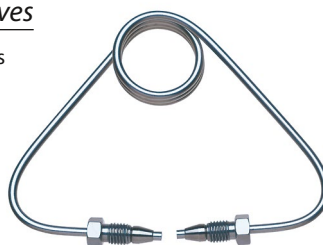

ABOUT LOOPS

- Other materials available in many sizes: Electroformed Nickel, Hastelloy C, Nickel 200, PEEK, PTFE, and Titanium
- Loops < 100 µl are made from 1/16" OD tubing with brazed or welded 1/8" tube ends..
- Sample loop shape and dimensions may vary from batch to batch due to fluctuations in tubing ID. Loop volume is controlled as closely as possible, but is not calibrated.

MORE INFORMATION

Actuators
 Air page 197
 Manual 204
 Microelectric 190-1
 Universal 193
 Materials
 Metals 254-255
 Polymers 256
 Valve rotors 257
 Standoff assemblies 205

4 port internal sample injector

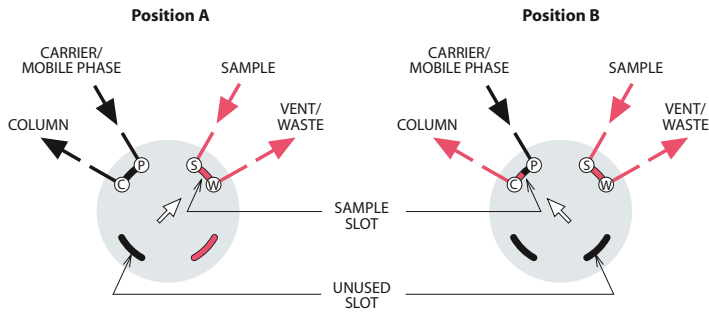

MICROVOLUME SAMPLE INJECTION

The internal sample (fixed volume) flowpath is used when very small sample volumes are required. The sample size is determined by a passage engraved on the valve rotor, allowing precise, repeatable injections. In Position A, the sample flows through the sample passage while the mobile phase flows through to the column. The third passage is inactive. In Position B, the sample passage is in line with the column and the mobile phase injects the contents of the sample passage onto the column. The passage which was inactive in Position A allows the sample to continue flowing without interruption.

6 port internal sample injector

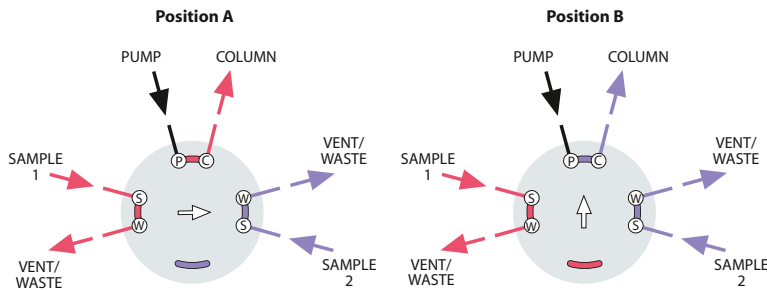

DUAL MICROVOLUME SAMPLE INJECTION

This microvolume injector can be used to alternate between two different samples. Each time the valve is switched, a sample is injected. By connecting the two sample inlets in series, the valve injects the sample each time the valve switches. This is particularly useful in heavy duty cycle operations to minimize valve wear. The valve can also be used to make alternating injections of the same sample onto two different columns by swapping sample/waste and pump/column connections.

Note: This CI6 valve is not shown in this catalog. Call for details.

3 port switching valve

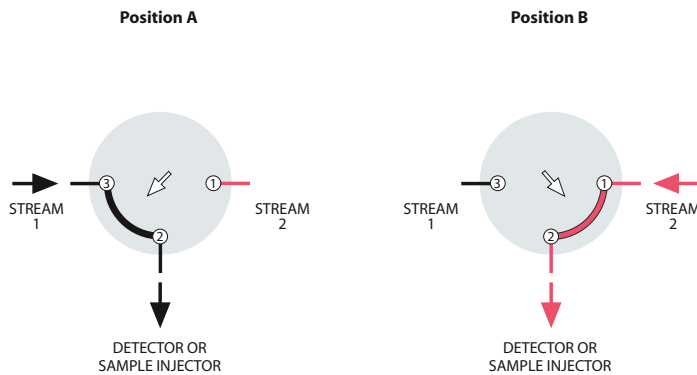

STREAM SELECTION WITHOUT MAINTAINED FLOW

This arrangement allows one of two sample points to flow to a sample injector or detector while blocking the other sample point's flow.

VALCO VALVES

4 port switching valve

DETECTOR SELECTION FROM TWO COLUMNS OR ONE COLUMN AND AUXILIARY CARRIER

This unique configuration allows analyses of different parts of one analysis with two different detectors, without splitting or multiple injections. For example, fixed gases can be analyzed with a thermal conductivity detector, followed by the analysis of a hydrocarbon fraction with a flame ionization detector.

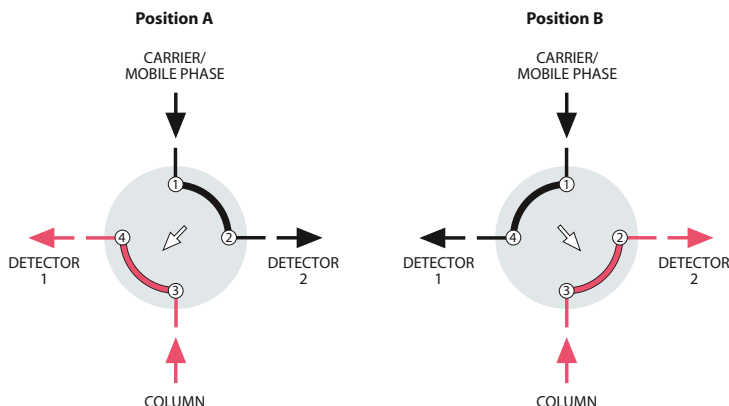

6 port external sample injector

SAMPLE INJECTION

With the valve in Position A, sample flows through the external loop while the mobile phase flows directly through to the chromatographic column. When the valve is switched to Position B, the sample contained in the sample loop and valve flow passage is displaced by the mobile phase and is carried onto the column.

Note: This is especially critical for partially-filled loops. The flow direction of the mobile phase through the loop should be opposite (backflush) to the flow direction during the loading of the loop.

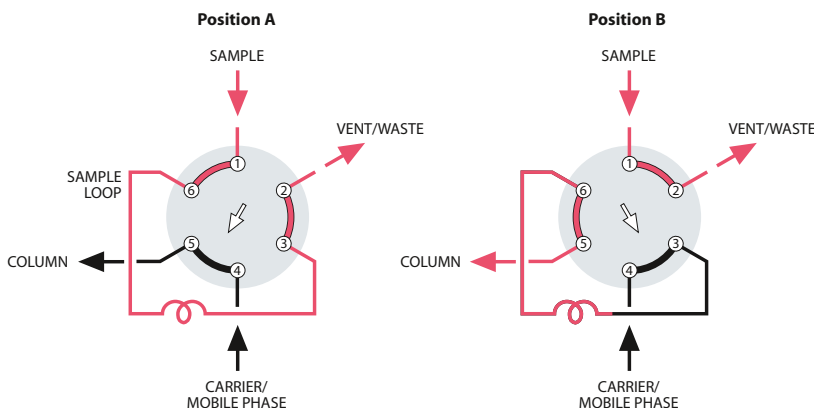

6 port column switching

BACKFLUSH OF PRECOLUMN TO VENT

This plumbing scheme allows slower eluting components (end cut) which are not of interest to be backflushed to vent. Often a shorter version of the analytical column is used as the precolumn. Once all the components of interest have entered the main column (at port 2), the valve switches, backflushing the precolumn to vent and reducing analysis time.

Note: An auxiliary source of carrier or mobile phase is required for this application.

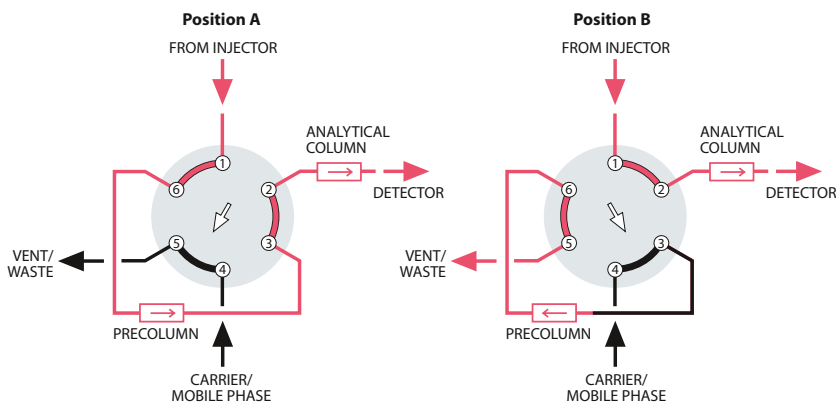

6 port column selection

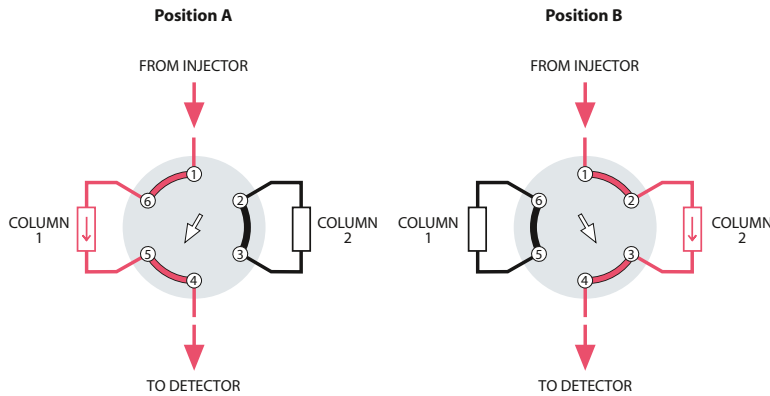

TWO COLUMN SELECTION

When two different columns are required at frequent intervals at similar oven temperatures, a 6 port valve can provide rapid selection of the one to be used. The column not in use is protected by a blanket of inert mobile phase and may be rapidly brought to equilibrium when required.

Note: If flow must be maintained to the non-selected column, an 8 or 10 port valve is required.

8 port dual external sample injector

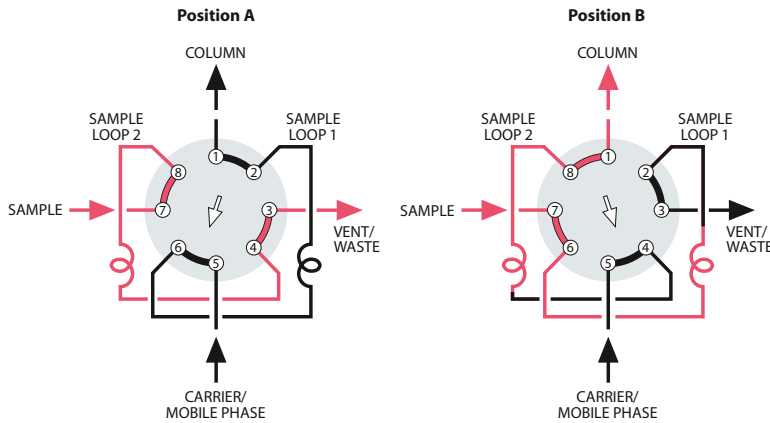

SAME SAMPLE TO DIFFERENT LOOPS

In a dual external sample loop configuration, sample is injected in both positions. In Position A, Loop 2 is loaded while the mobile phase flows through Loop 1 and onto the column. In Position B, the Loop 2 sample is injected into the column and another sample is loaded into Loop 1. When the valve is returned to Position A, the Loop 1 sample is injected onto the column and Loop 2 is reloaded.

8 port sampling/switching

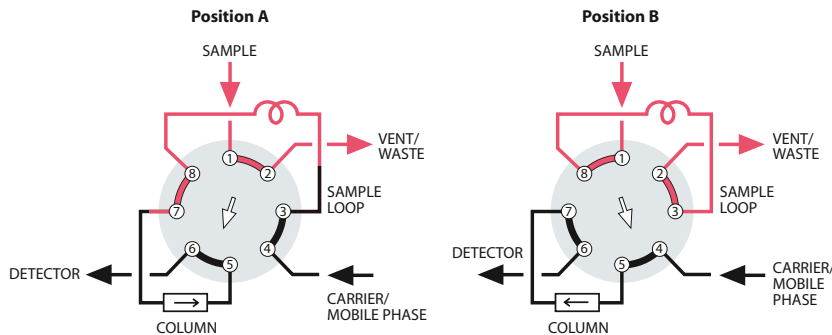

LOOP SAMPLING WITH BACKFLUSH TO DETECTOR

One valve functions as both a sampling and a backflush valve, simplifying operation and reducing cost. When components of interest are detected, the strongly retained components are backflushed and removed from the column without temperature programming.

VALCO VALVES

10 port dual external sampling

TWO DIFFERENT SAMPLES TO SAME COLUMN

A 10 port valve permits alternate injections from the two loops, which may be identical or of different sizes. This technique replaces a 4 port sample selector and a 6 port sample injector.

In Position A, Loop 2 is loaded with sample 2 while the mobile phase flows through Loop 1 and onto the column.

In Position B, the Loop 2 sample is injected onto the column and Loop 1 is loaded with sample 1. When the valve is returned to Position A, the Loop 1 sample is injected onto the column and Loop 2 is reloaded with sample 2.

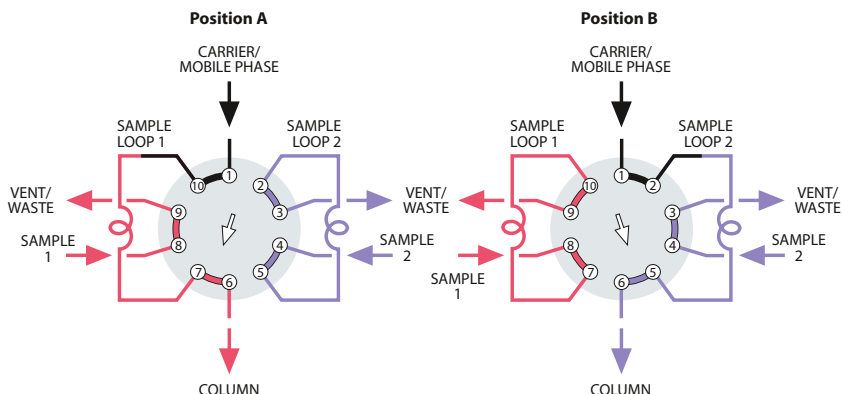

10 port dual external sampling

SIMULTANEOUS INJECTION OF THE SAME SAMPLE ONTO SEPARATE COLUMNS

In Position A, sample fills the two loops in series. In Position B, the sample is simultaneously injected into two separate flow systems. A single autosampler used with this flowpath can automate two analytical procedures for the same sample.

In an important non-chromatographic application, the roles of carrier and sample are reversed, permitting two different quantities of two different materials to be dispensed together, as in automatic dilution.

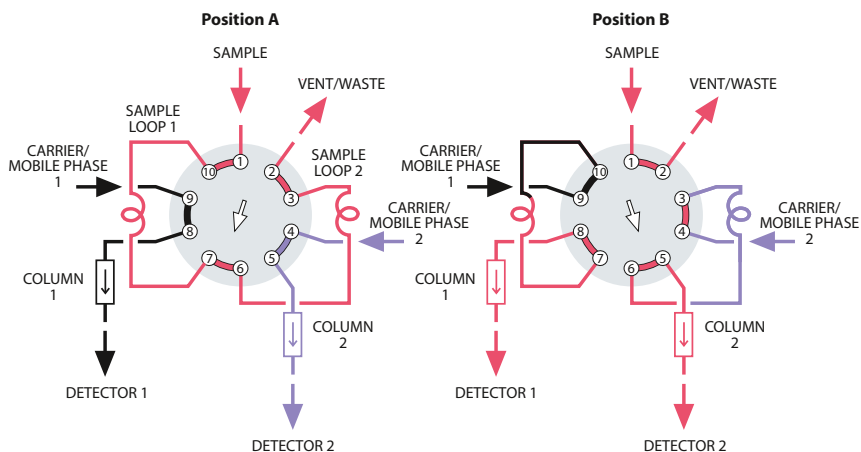

10 port sampling/switching

LOOP SAMPLING WITH BACKFLUSH OF PRE-COLUMN TO VENT

When components of interest have low boiling points, this plumbing scheme allows "heavy" components with long retention times to be backflushed to waste. After the sample loop is loaded in Position A, the valve is switched to Position B to inject the sample onto column 1. As soon as all components of interest have entered column 2, the valve is switched back to Position A. Column 1 is backflushed to vent during the analysis, reducing the total analysis time.

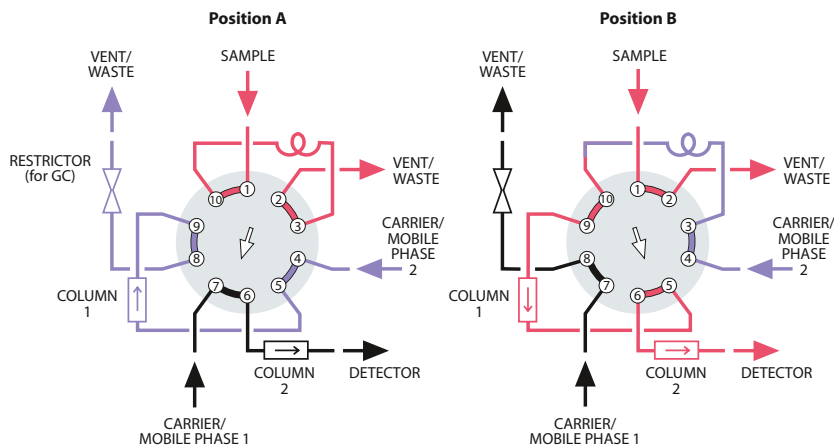

10 port sampling/switching

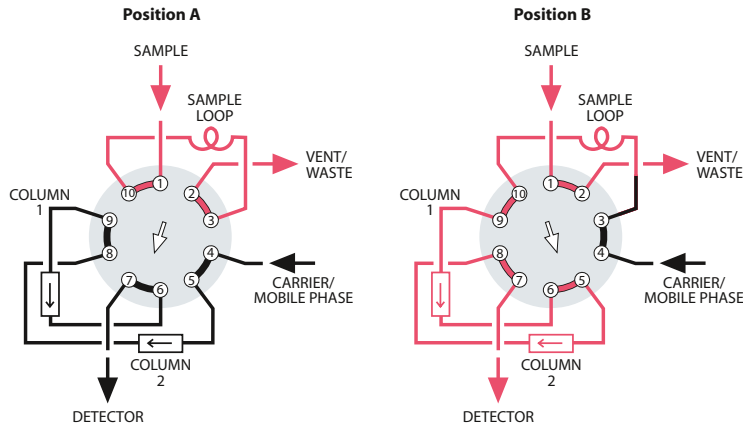

LOOP SAMPLING WITH TWO COLUMN SEQUENCE REVERSAL

This is ideal for fixed-gas-from-CO₂ analysis where no "high boilers" are present. Column 1 is packed with a porous polymer and Column 2 with molecular sieve. The sample loop is loaded in Position A. When the valve is switched, the loop contents are sent onto Column 1. As the inorganic gases and methane leave Column 1 and enter Column 2, the valve is returned to Position A, reversing the column sequence. CO₂ now leaves Column 1, becoming the first peak. The inorganics and methane are separated by the molecular sieve and pass through the porous polymer column to the detector.

10 port column switching

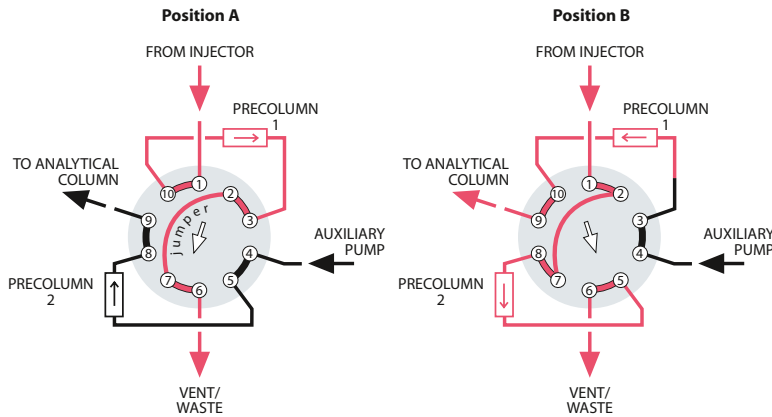

SAMPLE ENRICHMENT (CLEANUP) USING DUAL PRECOLUMNS

Sample is injected by a separate injector onto one of two precolumns (stripper). Early eluting components vent at port 6 while components of interest are retained on the stripper. When the valve is switched, a new injection is made onto the second stripper while components retained on the first stripper are backflushed onto the analytical column at port 9.

Note: This application requires an auxiliary pump at port 4.

10 port column switching

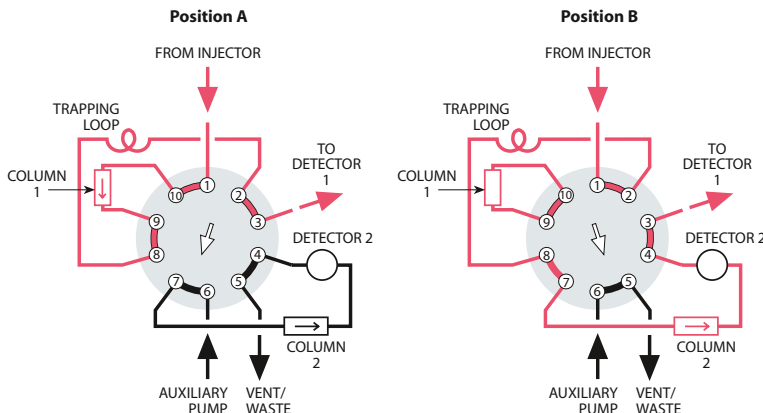

HEART CUT TRAPPED IN A LOOP AND INJECTED ONTO A SECOND COLUMN

Sample is injected (using a separate injector) onto an analytical column. Early eluting components (front cut) pass through a trapping loop and are detected (at port 3). The valve is then switched, and the center (or heartcut) which was retained in the trapping loop is injected onto the second column to the detector (at port 4). Late eluting components (end cut) are trapped on the first column. When the valve is switched again, the end cut passes through the trapping loop to the first detector, completing the analysis.

VALCO VALVES

Dead-end flowpath – SD configuration

SD valves select one of 4 to 12 dead-ended streams. The selected stream flows from the outlet to a sample valve, pressure sensor, detector, column, etc. The same flowpath can also be used to direct one stream to a number of outlets in applications such as fraction collection. For an application suggestion, see page 136.

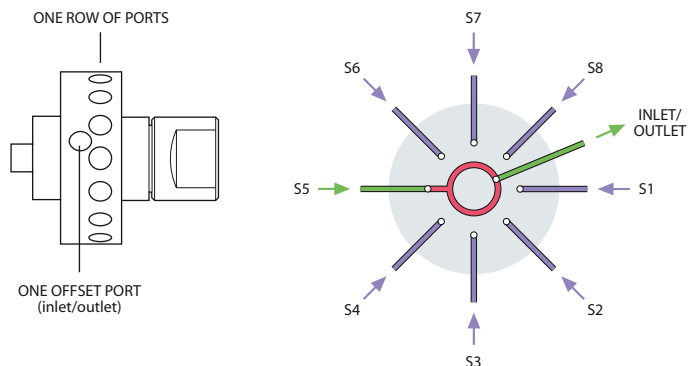

1/16" fittings, 0.75 mm ports (.030")

MW Type

Low pressure

SD Dead-end

1/16" 0.75 mm

Includes 2" standoff. Ask about closemount assembly if valve will not be heated.
Microelectric actuators: 24 VDC (includes a 110/230 VAC to 24 VDC power supply)

SPECS
400 psi gas
200°C max
Nitronic 60 body
Valcon E rotor

OPTIONS

- 4 and 8 positions available
- 3", 4", and 6" standoffs
- Materials: Hastelloy C, Inconel 600, Monel 400, Nickel 200, Nitronic 50, Titanium (see pages 254-255)
- Larger bore available except 16 position

	6 Position <i>Prod No</i>	10 Position <i>Prod No</i>	12 Position <i>Prod No</i>	16 Position <i>Prod No</i>
Manual (not recommended)	2CSD6MWE	2CSD10MWE	2CSD12MWE	2CSD16MWE
With air actuator	A2CSD6MWE	A2CSD10MWE	A2CSD12MWE	A2CSD16MWE
With microelectric actuator	EMT2CSD6MWE	EMT2CSD10MWE	EMT2CSD12MWE	EMT2CSD16MWE
Replacement valve	DCSD6MWE	DCSD10MWE	DCSD12MWE	DCSD16MWE
Replacement rotor	SSACSD6MWE	SSACSD10MWE	SSACSD12MWE	SSACSD16MWE

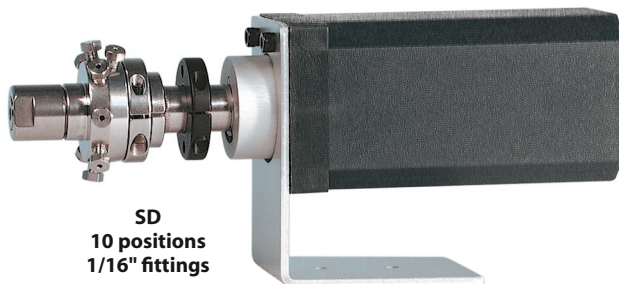

MORE INFORMATION

Application..... page 136

Actuators

- Air 196
- Microelectric 192
- Universal 193

Materials

- Metals..... 254-255
- Polymers 256
- Valve rotors..... 257

Mounting hardware

- Closemount 208
- Standoff..... 205

1/8" fittings, 1.0 mm ports (.040")

MW Type

SPECS

4-8 Positions:
400 psi gas
200°C max
 10-16 Positions:
200 psi gas
200°C max
 Nitronic 60 body
 Valcon E rotor

Includes 2" standoff. Ask about closemount assembly if valve will not be heated.
 Microelectric actuators: 24 VDC (includes a 110/230 VAC to 24 VDC power supply)

OPTIONS

- 4 and 8 positions available
- 3", 4", and 6" standoffs
- Materials: Hastelloy C, Inconel 600, Monel 400, Nickel 200, Nitronic 50, Titanium (see pages 254-255)
- Larger bore available

Low pressure

SD
Dead-end

1/8"

1.0 mm

	6 Position <i>Prod No</i>	10 Position <i>Prod No</i>	12 Position <i>Prod No</i>	16 Position <i>Prod No</i>
Manual (not recommended)	2SD6MWE	2SD10MWE	2SD12MWE	2SD16MWE
With air actuator	A2SD6MWE	A2SD10MWE	A2SD12MWE	A2SD16MWE
With microelectric actuator	EMT2SD6MWE	EMT2SD10MWE	EMT2SD12MWE	EMT2SD16MWE
Replacement valve	DSD6MWE	DSD10MWE	DSD12MWE	DSD16MWE
Replacement rotor	SSASD6MWE	SSASD10MWE	SSASD12MWE	SSASD16MWE

1/4" fittings, 4.0 mm ports (.156")

MW Type

SPECS

100 psi gas
75°C max
 Nitronic 60 body
 Valcon E2 rotor

Includes 2" standoff. Ask about closemount assembly if valve will not be heated.
 Manual version not available.
 Microelectric actuators: 24 VDC (includes a 110/230 VAC to 24 VDC power supply)

OPTIONS

- 3", 4", and 6" standoffs
- Materials: Hastelloy C, Inconel 600, Monel 400, Nickel 200, Nitronic 50, Titanium (see pages 254-255)

Low pressure

SD
Dead-end

1/4"

4.0 mm

	4 Position <i>Prod No</i>	6 Position <i>Prod No</i>	8 Position <i>Prod No</i>	10 Position <i>Prod No</i>
With air actuator	AH2VLS4MWE2	AH2VLS6MWE2	AH2VLS8MWE2	AH2VLS10MWE2
With microelectric actuator	EMT2VLS4MWE2	EMT2VLS6MWE2	EMT2VLS8MWE2	EMT2VLS10MWE2
Replacement valve	DVLS4MWE2	DVLS6MWE2	DVLS8MWE2	DVLS10MWE2
Replacement rotor	SSAVLS4MWE2	SSAVLS6MWE2	SSAVLS8MWE2	SSAVLS10MWE2

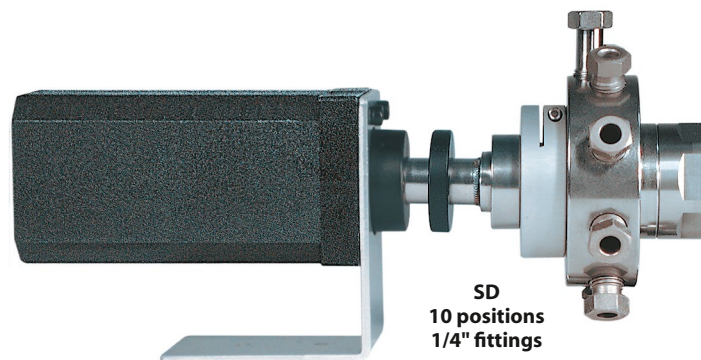

VALCO VALVES

Common outlet flowpath – SC configuration

SC selectors are similar to the SD configuration, except that instead of being dead-ended the non-selected streams flow to a common outlet. For an application suggestion, see page 137.

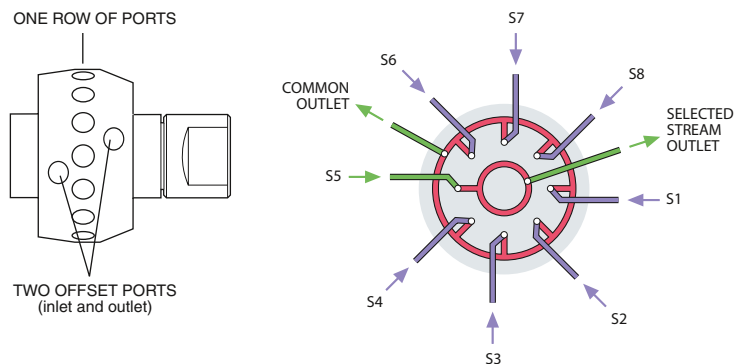

1/16" fittings, 1.0 mm ports (.040")

MW Type

Low pressure

SC
Common outlet

1/16" **1.0 mm**

Includes 2" standoff. Ask about closemount assembly if valve will not be heated.
Microelectric actuators: 24 VDC (includes a 110/230 VAC to 24 VDC power supply)

SPECS
200 psi gas
200°C max
Nitronic 60 body
Valcon E rotor

OPTIONS

- 4 and 8 positions available
- 3", 4", and 6" standoffs
- Materials: Hastelloy C, Inconel 600, Monel 400, Nickel 200, Nitronic 50, Titanium (see pages 254-255)

	6 Position <i>Prod No</i>	10 Position <i>Prod No</i>	12 Position <i>Prod No</i>	16 Position <i>Prod No</i>
Manual (not recommended)	2CSC6MWE	2CSC10MWE	2CSC12MWE	2CSC16MWE
With air actuator	AH2CSC6MWE	A2CSC10MWE	A2CSC12MWE	A2CSC16MWE
With microelectric actuator	EMT2CSC6MWE	EMT2CSC10MWE	EMT2CSC12MWE	EMT2CSC16MWE
Replacement valve	DCSC6MWE	DCSC10MWE	DCSC12MWE	DCSC16MWE
Replacement rotor	SSACSC6MWE	SSACSC10MWE	SSACSC12MWE	SSACSC16MWE

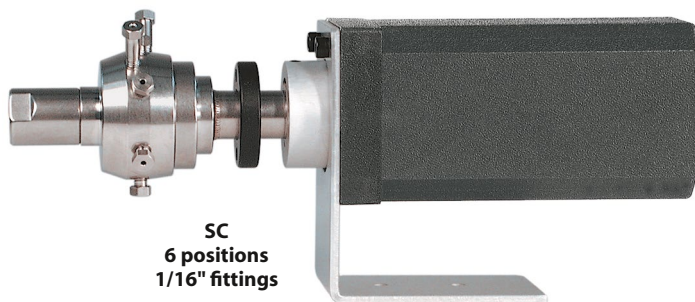

MORE INFORMATION

Application..... page 137

Actuators

- Air 196
- Microelectric 192
- Universal 193

Materials

- Metals..... 254-255
- Polymers 256
- Valve rotors..... 257

Mounting hardware

- Closemount 208
- Standoff..... 205

1/8" fittings, 1.0 mm ports (.040")

MW Type

SPECS

200 psi gas
200°C max
Nitronic 60 body
Valcon E rotor

Includes 2" standoff. Ask about closemount assembly if valve will not be heated.
Microelectric actuators: 24 VDC (includes a 110/230 VAC to 24 VDC power supply)

Low pressure

SC
Common outlet

1/8" 1.0 mm

OPTIONS

- 4 and 8 positions available
- 3", 4", and 6" standoffs
- Materials: Hastelloy C, Inconel 600, Monel 400, Nickel 200, Nitronic 50, Titanium (see pages 254-255)
- Larger bore available except 16 position

	6 Position <i>Prod No</i>	10 Position <i>Prod No</i>	12 Position <i>Prod No</i>	16 Position <i>Prod No</i>
Manual (not recommended)	2SC6MWE	2SC10MWE	2SC12MWE	2SC16MWE
With air actuator	AH2SC6MWE	A2SC10MWE	A2SC12MWE	A2SC16MWE
With microelectric actuator	EMT2SC6MWE	EMT2SC10MWE	EMT2SC12MWE	EMT2SC16MWE
Replacement valve	DSC6MWE	DSC10MWE	DSC12MWE	DSC16MWE
Replacement rotor	SSASC6MWE	SSASC10MWE	SSASC12MWE	SSASC16MWE

1/4" fittings, 4.0 mm ports (.156")

MW Type

SPECS

100 psi gas
75°C max
Nitronic 60 body
Valcon E2 rotor

Includes 2" standoff. Ask about closemount assembly if valve will not be heated.
Manual version not available.
Microelectric actuators: 24 VDC (includes a 110/230 VAC to 24 VDC power supply)

Low pressure

SC
Common outlet

1/4" 4.0 mm

OPTIONS

- 3", 4", and 6" standoffs
- Materials: Hastelloy C, Inconel 600, Monel 400, Nickel 200, Nitronic 50, Titanium (see pages 254-255)

	4 Position <i>Prod No</i>	6 Position <i>Prod No</i>	8 Position <i>Prod No</i>
With air actuator	AH2VLSC4MWE2	AH2VLSC6MWE2	AH2VLSC8MWE2
With microelectric actuator	EMT2VLSC4MWE2	EMT2VLSC6MWE2	EMT2VLSC8MWE2
Replacement valve	DVLSC4MWE2	DVLSC6MWE2	DVLSC8MWE2
Replacement rotor	SSAVLSC4MWE2	SSAVLSC6MWE2	SSAVLSC8MWE2

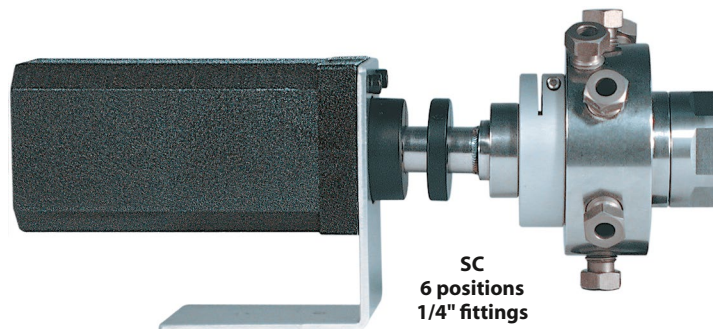

VALCO VALVES

Flow-through flowpath – SF configuration

SD and SC valves select and isolate one of 4 to 16 streams, with the remainder dead-ended in the SD and flowing to a common outlet in the SC. The SF selector is similar, but carries the evolution a step further with the non-selected streams flowing through individual outlets. For an application suggestion, see page 138.

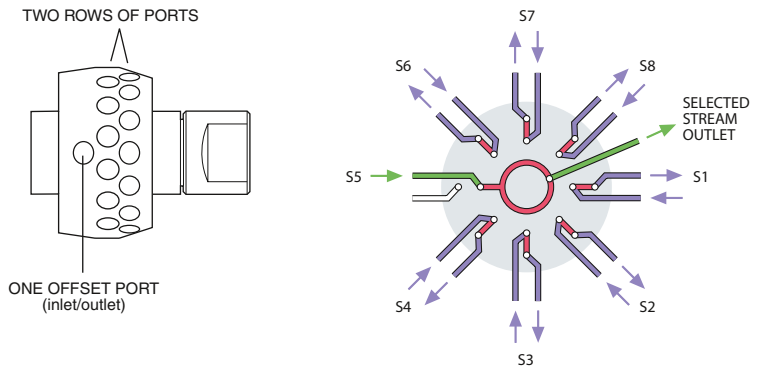

1/16" fittings, 1.0 mm ports (.040")

MW Type

Low pressure

SF
Flow-through

1/16" **1.0 mm**

Includes 2" standoff. Ask about closemount assembly if valve will not be heated.
Microelectric actuators: 24 VDC (includes a 110/230 VAC to 24 VDC power supply)

SPECS
200 psi gas
200°C max
Nitronic 60 body
Valcon E rotor

OPTIONS

- 4 and 8 positions available
- 3", 4", and 6" standoffs
- Materials: Hastelloy C, Inconel 600, Monel 400, Nickel 200, Nitronic 50, Titanium (see pages 254-255)

	6 Position <i>Prod No</i>	10 Position <i>Prod No</i>	12 Position <i>Prod No</i>	16 Position <i>Prod No</i>
Manual (not recommended)	2CSF6MWE	2CSF10MWE	2CSF12MWE	2CSF16MWE
With air actuator	AH2CSF6MWE	A2CSF10MWE	A2CSF12MWE	A2CSF16MWE
With microelectric actuator	EMT2CSF6MWE	EMT2CSF10MWE	EMT2CSF12MWE	EMT2CSF16MWE
Replacement valve	DCSF6MWE	DCSF10MWE	DCSF12MWE	DCSF16MWE
Replacement rotor	SSACSF6MWE	SSACSF10MWE	SSACSF12MWE	SSACSF16MWE

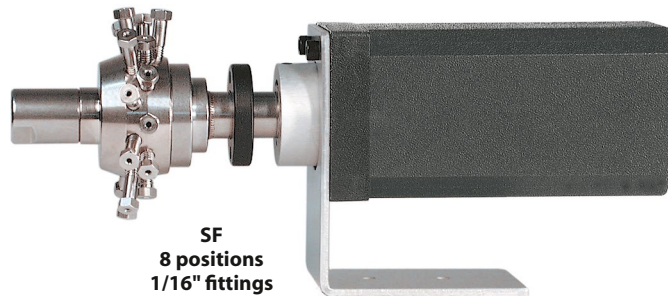

MORE INFORMATION

Application..... page 138

Actuators

- Air 196
- Microelectric 192
- Universal 193

Materials

- Metals..... 254-255
- Polymers 256
- Valve rotors..... 257

Mounting hardware

- Closemount 208
- Standoff..... 205

1/8" fittings, 1.0 mm ports (.040")

MW Type

SPECS

200 psi gas
200°C max
Nitronic 60 body
Valcon E rotor

Includes 2" standoff. Ask about closemount assembly if valve will not be heated.
Microelectric actuators: 24 VDC (includes a 110/230 VAC to 24 VDC power supply)

Low pressure

SF
Flow-through

1/8" 1.0 mm

OPTIONS

- 4 and 8 positions available
- 3", 4", and 6" standoffs
- Materials: Hastelloy C, Inconel 600, Monel 400, Nickel 200, Nitronic 50, Titanium (see pages 254-255)
- Larger bore available except 16 position

	6 Position <i>Prod No</i>	10 Position <i>Prod No</i>	12 Position <i>Prod No</i>	16 Position <i>Prod No</i>
Manual (not recommended)	2SF6MWE	2SF10MWE	2SF12MWE	2SF16MWE
With air actuator	AH2SF6MWE	A2SF10MWE	A2SF12MWE	A2SF16MWE
With microelectric actuator	EMT2SF6MWE	EMT2SF10MWE	EMT2SF12MWE	EMT2SF16MWE
Replacement valve	DSF6MWE	DSF10MWE	DSF12MWE	DSF16MWE
Replacement rotor	SSASF6MWE	SSASF10MWE	SSASF12MWE	SSASF16MWE

1/4" fittings, 4.0 mm ports (.156")

MW Type

SPECS

100 psi gas
75°C max
Nitronic 60 body
Valcon E2 rotor

Includes 2" standoff. Ask about closemount assembly if valve will not be heated.
Manual version is not available.
Microelectric actuators: 24 VDC (includes a 110/230 VAC to 24 VDC power supply)

Low pressure

SF
Flow-through

1/4" 4.0 mm

OPTIONS

- 3", 4", and 6" standoffs
- Materials: Hastelloy C, Inconel 600, Monel 400, Nickel 200, Nitronic 50, Titanium (see pages 254-255)

	4 Position <i>Prod No</i>	6 Position <i>Prod No</i>	8 Position <i>Prod No</i>
With air actuator	AH2VLSF4MWE2	AH2VLSF6MWE2	AH2VLSF8MWE2
With microelectric actuator	EMT2VLSF4MWE2	EMT2VLSF6MWE2	EMT2VLSF8MWE2
Replacement valve	DVLSF4MWE2	DVLSF6MWE2	DVLSF8MWE2
Replacement rotor	SSAVLSF4MWE2	SSAVLSF6MWE2	SSAVLSF8MWE2

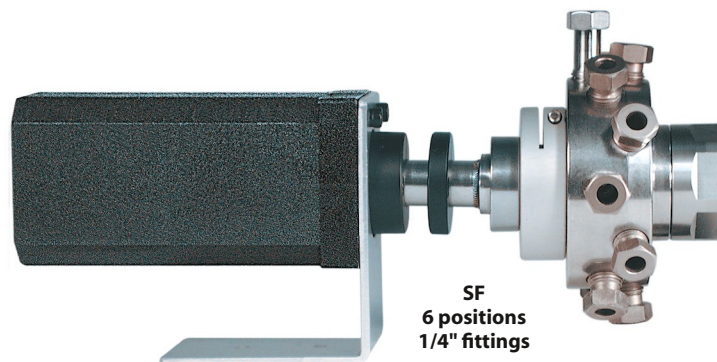

VALCO VALVES

Trapping flowpath – ST configuration

ST selectors are used for multi-column, multi-sample, or multi-trap operations, and are available for use with 4 to 16 loops, or positions. For an application suggestion, see page 139.

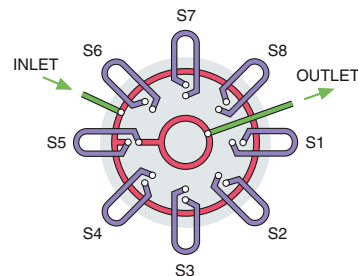
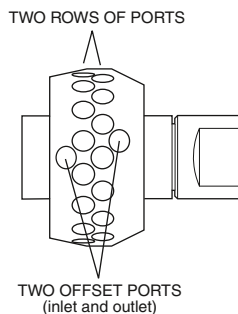

1/16" fittings, 0.75 mm ports (.030")

MW Type

Low pressure

ST Trapping

1/16" 0.75 mm

Includes 2" standoff. Ask about closemount assembly if valve will not be heated.
Microelectric actuators: 24 VDC (includes a 110/230 VAC to 24 VDC power supply)

SPECS
200 psi gas
200°C max
Nitronic 60 body
Valcon E rotor

OPTIONS

- 4 and 8 positions available
- 3", 4", and 6" standoffs
- Materials: Hastelloy C, Inconel 600, Monel 400, Nickel 200, Nitronic 50, Titanium (see pages 254-255)

	6 Position <i>Prod No</i>	10 Position <i>Prod No</i>	12 Position <i>Prod No</i>	16 Position <i>Prod No</i>
Manual (not recommended)	2CST6MWE	2CST10MWE	2CST12MWE	2CST16MWE
With air actuator	AH2CST6MWE	A2CST10MWE	A2CST12MWE	A2CST16MWE
With microelectric actuator	EMT2CST6MWE	EMT2CST10MWE	EMT2CST12MWE	EMT2CST16MWE
Replacement valve	DCST6MWE	DCST10MWE	DCST12MWE	DCST16MWE
Replacement rotor	SSACST6MWE	SSACST10MWE	SSACST12MWE	SSACST16MWE

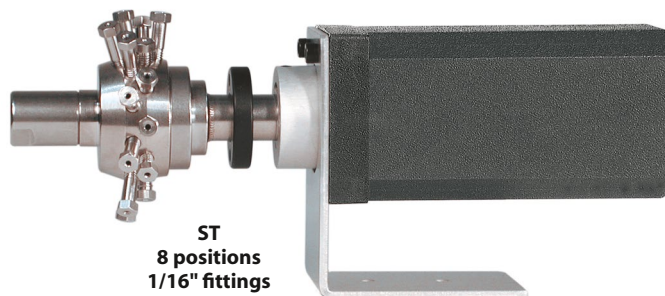

1/16" Stainless steel loops for MW Type valves

Each stainless steel loop includes two stainless nuts and two stainless ferrules. Order special fittings separately. **Request matched loops when loops will be installed on a single valve.**

Volume	Prod No	Volume	Prod No
50 µl	SL50CSTP	1 ml	SL1KCSTP
100 µl	SL100CSTP	2 ml	SL2KCSTP
250 µl	SL250CSTP	5 ml	SL5KCSTP
500 µl	SL500CSTP	10 ml	SL10KCSTP



MORE INFORMATION

Application..... page 139

Actuators

- Air 196
- Microelectric 192
- Universal 193

Materials

- Metals..... 254-255
- Polymers 256
- Valve rotors..... 257

Mounting hardware

- Closemount 208
- Standoff..... 205

1/8" fittings, 1.0 mm ports (.040")

MW Type

SPECS

200 psi gas
200°C max
Nitronic 60 body
Valcon E rotor

Includes 2" standoff. Ask about closemount assembly if valve will not be heated.
Microelectric actuators: 24 VDC (includes a 110/230 VAC to 24 VDC power supply)

Low pressure

ST
Trapping

1/8"

1.0 mm

OPTIONS

- 4 and 8 positions available
- 3", 4", and 6" standoffs
- Materials: Hastelloy C, Inconel 600, Monel 400, Nickel 200, Nitronic 50, Titanium (see pages 254-255)
- Larger bore available except 16 position

	6 Position <i>Prod No</i>	10 Position <i>Prod No</i>	12 Position <i>Prod No</i>	16 Position <i>Prod No</i>
Manual (not recommended)	2ST6MWE	2ST10MWE	2ST12MWE	2ST16MWE
With air actuator	AH2ST6MWE	A2ST10MWE	A2ST12MWE	A2ST16MWE
With microelectric actuator	EMT2ST6MWE	EMT2ST10MWE	EMT2ST12MWE	EMT2ST16MWE
Replacement valve	DST6MWE	DST10MWE	DST12MWE	DST16MWE
Replacement rotor	SSAST6MWE	SSAST10MWE	SSAST12MWE	SSAST16MWE

ABOUT LOOPS

- Other materials are available in many sizes: Electroformed Nickel, Hastelloy C, Nickel 200, PEEK, PTFE, and Titanium
- 1/16" loops > 2 ml are made from 1/8" OD tubing with brazed or welded 1/16" tube ends or reducing unions.
- 1/8" loops < 100 µl are made from 1/16" OD tubing with brazed or welded 1/8" tube ends.
- Sample loop shape and dimensions may vary from batch to batch due to fluctuations in tubing ID. Loop volume is controlled as closely as possible, but is not calibrated.



1/8" Stainless steel loops for MW Type valves

Each stainless steel loop includes two stainless nuts and two stainless ferrules. Order special fittings separately. **Request matched loops when loops will be installed on a single valve.**

Volume	Prod No	Volume	Prod No
100 µl	SL100STP	1 ml	SL1KSTP
250 µl	SL250STP	2 ml	SL2KSTP
500 µl	SL500STP	5 ml	SL5KSTP
		10 ml	SL10KSTP

VALCO VALVES

Trapping/flow-through flowpath – STF configuration

The STF selector is a variation of the ST flowpath, with the single difference that the non-selected streams are returned to their own vents or sources rather than being dead-ended or trapped as they are in the standard ST configuration. For an application suggestion, see page 140.

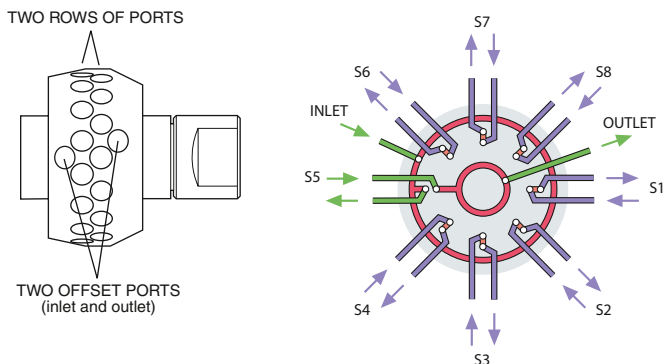

1/16" fittings, 0.75 mm ports (.030")

MW Type

Low pressure

STF
Trap/ flow-throw

1/16" **0.75 mm**

Includes 2" standoff. Ask about closemount assembly if valve will not be heated.
Microelectric actuators: 24 VDC (includes a 110/230 VAC to 24 VDC power supply)

SPECS
200 psi gas
200°C max
Nitronic 60 body
Valcon E rotor

OPTIONS

- 4 and 8 positions available
- 3", 4", and 6" standoffs
- Materials: Hastelloy C, Inconel 600, Monel 400, Nickel 200, Nitronic 50, Titanium (see pages 254-255)

	6 Position <i>Prod No</i>	10 Position <i>Prod No</i>	12 Position <i>Prod No</i>	16 Position <i>Prod No</i>
Manual (not recommended)	2CSTF6MWE	2CSTF10MWE	2CSTF12MWE	2CSTF16MWE
With air actuator	AH2CSTF6MWE	A2CSTF10MWE	A2CSTF12MWE	A2CSTF16MWE
With microelectric actuator	EMT2CSTF6MWE	EMT2CSTF10MWE	EMT2CSTF12MWE	EMT2CSTF16MWE
Replacement valve	DCSTF6MWE	DCSTF10MWE	DCSTF12MWE	DCSTF16MWE
Replacement rotor	SSACSTF6MWE	SSACSTF10MWE	SSACSTF12MWE	SSACSTF16MWE

MORE INFORMATION

Application..... page 140

Actuators

- Air 196
- Microelectric 192
- Universal 193

Materials

- Metals..... 254-255
- Polymers 256
- Valve rotors..... 257

Mounting hardware

- Closemount 208
- Standoff..... 205

1/8" fittings, 1.0 mm ports (.040")

MW Type

SPECS

200 psi gas
200°C max
Nitronic 60 body
Valcon E rotor

Includes 2" standoff. Ask about closemount assembly if valve will not be heated.
Microelectric actuators: 24 VDC (includes a 110/230 VAC to 24 VDC power supply)

OPTIONS

- 4 and 8 positions available
- 3", 4", and 6" standoffs
- Materials: Hastelloy C, Inconel 600, Monel 400, Nickel 200, Nitronic 50, Titanium (see pages 254-255)
- Larger bore available except 16 position

Low pressure

STF
Trap/ flow-throw

1/8" 1.0 mm

	6 Position <i>Prod No</i>	10 Position <i>Prod No</i>	12 Position <i>Prod No</i>	16 Position <i>Prod No</i>
Manual (not recommended)	2STF6MWE	2STF10MWE	2STF12MWE	2STF16MWE
With air actuator	AH2STF6MWE	A2STF10MWE	A2STF12MWE	A2STF16MWE
With microelectric actuator	EMT2STF6MWE	EMT2STF10MWE	EMT2STF12MWE	EMT2STF16MWE
Replacement valve	DSTF6MWE	DSTF10MWE	DSTF12MWE	DSTF16MWE
Replacement rotor	SSASTF6MWE	SSASTF10MWE	SSASTF12MWE	SSASTF16MWE

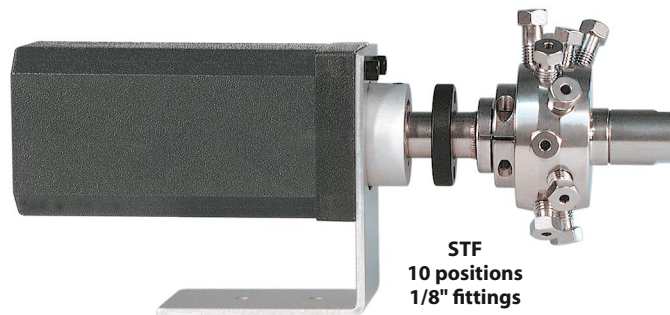

VALCO VALVES

Dead-end flowpath – SD configuration

SD valves select one of 4 to 12 dead-ended streams. The selected stream flows from the valve outlet to a sample valve, pressure sensor, detector, column, etc. This configuration may also be used to direct one stream to a number of outlets for applications such as fraction collection. For an application suggestion, see page 141.

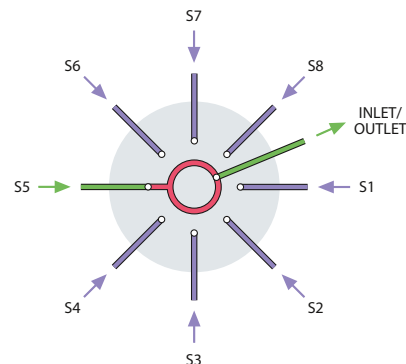
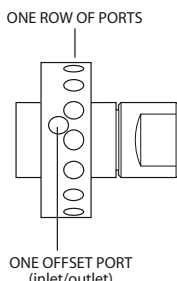

1/16" fittings, 0.4 mm ports (.016")

UW Type

5,000 psi

Microelectric actuators: 24 VDC (includes a 110/230 VAC to 24 VDC power supply)

SD Dead-end

OPTIONS

- 8 and 12 positions available
- 2", 3", 4", and 6" standoffs
- Materials: Hastelloy C, Inconel 600, Monel 400, Nickel 200, Nitronic 50, Titanium (see p. 254-255)
- Low pressure, high temperature versions available
- Larger bore available except 10 and 12 positions

1/16" 0.40 mm

SPECS

5000 psi liq
75°C max
 Nitronic 60 body
 Valcon E rotor

	4 Position <i>Prod No</i>	6 Position <i>Prod No</i>	10 Position <i>Prod No</i>
Manual (not recommended)	CSD4UW	CSD6UW	CSD10UW
With air actuator	ACSD4UW	ACSD6UW	ACSD10UW
With microelectric actuator	EMTCS4UW	EMTCS6UW	EMTCS10UW
Replacement valve	DCSD4UW	DCSD6UW	DCSD10UW
Replacement rotor	SSACSD4UW	SSACSD6UW	SSACSD10UW

1/8" fittings, 0.75 mm ports (.030")

UW Type

5,000 psi

Microelectric actuators: 24 VDC (includes a 110/230 VAC to 24 VDC power supply)

SD Dead-end

OPTIONS

- 2", 3", 4", and 6" standoffs
- Materials: Hastelloy C, Inconel 600, Monel 400, Nickel 200, Nitronic 50, Titanium (see p. 254-255)
- Low pressure, high temperature versions available
- Larger bore available except 8 position

1/8" 0.75 mm

SPECS

5000 psi liq
75°C max
 Nitronic 60 body
 Valcon E rotor

	4 Position <i>Prod No</i>	6 Position <i>Prod No</i>	8 Position <i>Prod No</i>
Manual (not recommended)	SD4UW	SD6UW	SD8UW
With air actuator	ASD4UW	ASD6UW	ASD8UW
With microelectric actuator	EMTSD4UW	EMTSD6UW	EMTSD8UW
Replacement valve	DSD4UW	DSD6UW	DSD8UW
Replacement rotor	SSASD4UW	SSASD6UW	SSASD8UW

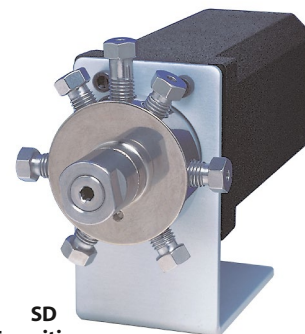

SD
6 positions
1/8" fittings

Both column ends selected – ST configuration

ST selectors are used for multi-column, multi-sample, or multi-trap operations. This valve can be used between an injector and detector to permit manual or automated HPLC column selection. For an application suggestion, see page 141.

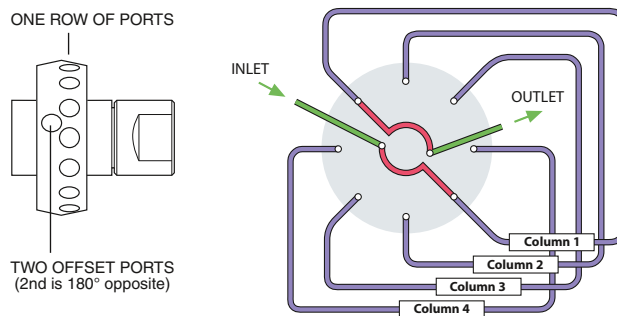

1/16" fittings, 0.4 mm ports (.016")

UW Type

SPECS

5000 psi liq
75°C max
Nitronic 60 body
Valcon E rotor

Manual versions are not available.

Microelectric actuators: 24 VDC (includes a 110/230 VAC to 24 VDC power supply).

OPTIONS

- 2", 3", 4", and 6" standoffs
- Materials: Hastelloy C, Inconel 600, Monel 400, Nickel 200, Nitronic 50, Titanium (see p.254-255)
- Low pressure, high temperature versions available. (Consult factory.)

5,000 psi

ST Trapping

1/16" 0.4 mm

4 Columns or Loops

Prod No

With air actuator
With microelectric actuator

ACST4UW
EMTCST4UW

6 Columns or Loops

Prod No

ACST6UW
EMTCST6UW

Replacement valve
Replacement rotor

DCST4UW
SSACST4UW

DCST6UW
SSACST6UW



ST
4 position
1/16" fittings

ABOUT LOOPS

- Other materials are available in many sizes: Electroformed Nickel, Hastelloy C, Nickel 200, PEEK, PTFE, and Titanium
- Loops > 2 ml are made from 1/8" OD tubing with brazed or welded 1/16" tube ends or reducing unions.
- Sample loop shape and dimensions may vary from batch to batch due to fluctuations in tubing ID. Loop volume is controlled as closely as possible, but is not calibrated.



1/16" Stainless steel loops for UW Type valves

Each stainless steel loop includes two stainless nuts and two stainless ferrules. Order special fittings separately. **Request matched loops when loops will be installed on a single valve.**

Volume	Prod No	Volume	Prod No
10 µl	SL10CSTUW	250 µl	SL250CSTUW
15 µl	SL15CSTUW	500 µl	SL500CSTUW
20 µl	SL20CSTUW	1 ml	SL1KCSTUW
25 µl	SL25CSTUW	2 ml	SL2KCSTUW
50 µl	SL50CSTUW	5 ml	SL5KCSTUW
100 µl	SL100CSTUW	10 ml	SL10KCSTUW

SD flowpath — low pressure

STREAM SELECTION WITH DEAD-ENDED STREAMS

SD valves select one of 4 to 16 dead-ended streams. The selected stream flows from the valve outlet to a sample valve, pressure sensor, detector, column, etc. The same configuration may also be used to direct one stream to a number of outlets for applications such as fraction collection.

This example illustrates automated sampling of non-pressurized containers.

1 A vacuum pump is used to move sample from the containers to a 6 port sampling valve. **2** The 3 port valve is used to block the vacuum flow through the sampling valve to allow the sample within the loop to equilibrate at atmospheric pressure. **3** The 6 port valve is then switched, injecting the sample. This method eliminates any possible effect from pressure differences among the containers, providing accurate and repeatable results. All three valves can be automated with air or electric actuators for unattended operation.

The SD flowpath isolates the unselected sample streams, but the potential exists for extraneous sample or contaminants to be in the lines when containers are first connected. To avoid problems, either prepurge each line or allow sufficient sampling time for the line to purge prior to injection.

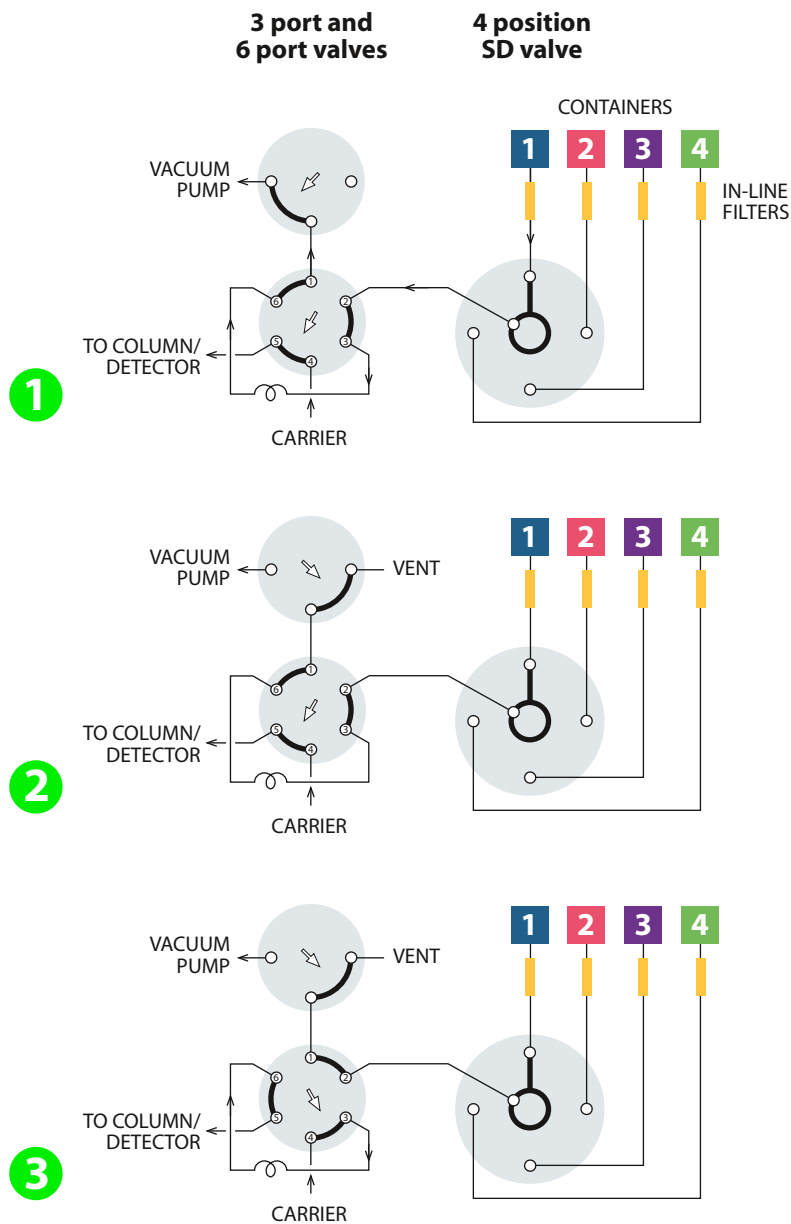

MORE INFORMATION

SD prices
 Low pressure . . . 124-125
 High pressure 134
 Application
 High pressure SD . . . 141

SC flowpath

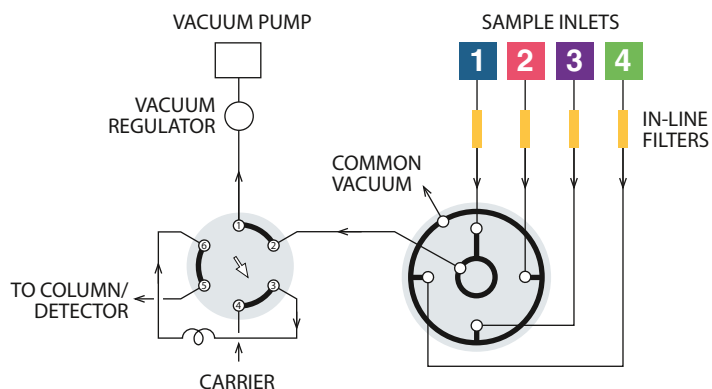
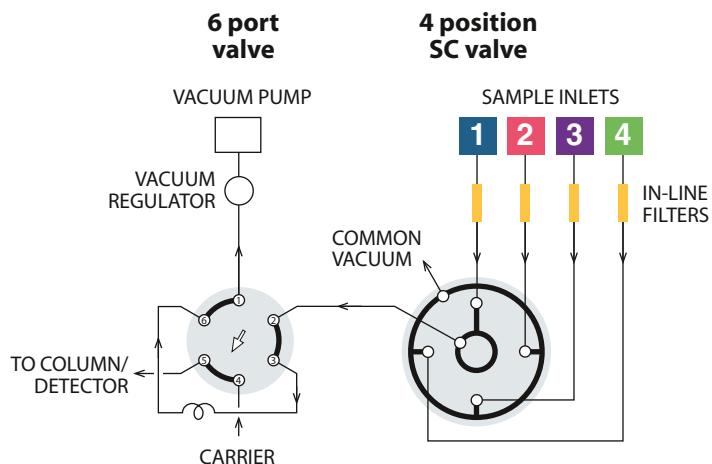

STREAM SELECTION WITH CONTINUOUS FLOW TO A COMMON OUTLET

SC selectors are similar to the SD configuration, except that instead of being dead-ended the non-selected streams flow to a common outlet. They are also available in 4, 6, 8, 10, 12, or 16 position versions.

The SC configuration is ideal for air quality monitoring, illustrated in this example.

The application is essentially the same as the one shown for the SD selectors on the previous page, except that the non-selected streams are continuously pulled through the valve, insuring that the most current sample will be provided as each point is selected for analysis. ① The sample loop on the 6 port valve is loaded from Stream 1. ② The 6 port valve is switched, injecting the sample. Both valves can be automated with air or electric actuators for unattended operation.

TECH TIP

Because the most common cause of valve failure is stray particulates entering the valve, we strongly recommend the use of in-line filters at sample entry points.

Our ZUFR filters feature inexpensive and easily replaceable low pressure drop filter screens (2 or 10 micron). The filters are available in 1/16", 1/8", and 1/4" standard, reducing, and bulkhead versions.

Filters pages 50-52

MORE INFORMATION

Actuators

Air page 196

Mod. universal 194

Universal 193

SC prices 126-127

SF flowpath

STREAM SELECTION WITH CONTINUOUS FLOW TO INDIVIDUAL OUTLETS

SD and SC valves select and isolate one of 4 to 16 streams, with the remainder dead-ended in the SD and flowing to a common outlet in the SC. The SF selector is similar, but carries the evolution a step further with the non-selected streams flowing through individual outlets.

This is the ideal solution when reactions or process streams with differing upstream pressures must be analyzed, and can also provide independent containment of toxic or noxious streams. An SF selector together with a 6 port sampling valve and pneumatic or electric actuators comprise a complete sampling system for the automated analysis of up to 16 sample points.

Note that streams 1 and 4 are vented while streams 2 and 3 are returned to their sources in this example.

Mode ① shows sample loading from stream 4, while mode ② shows sample injected onto the analytical column.

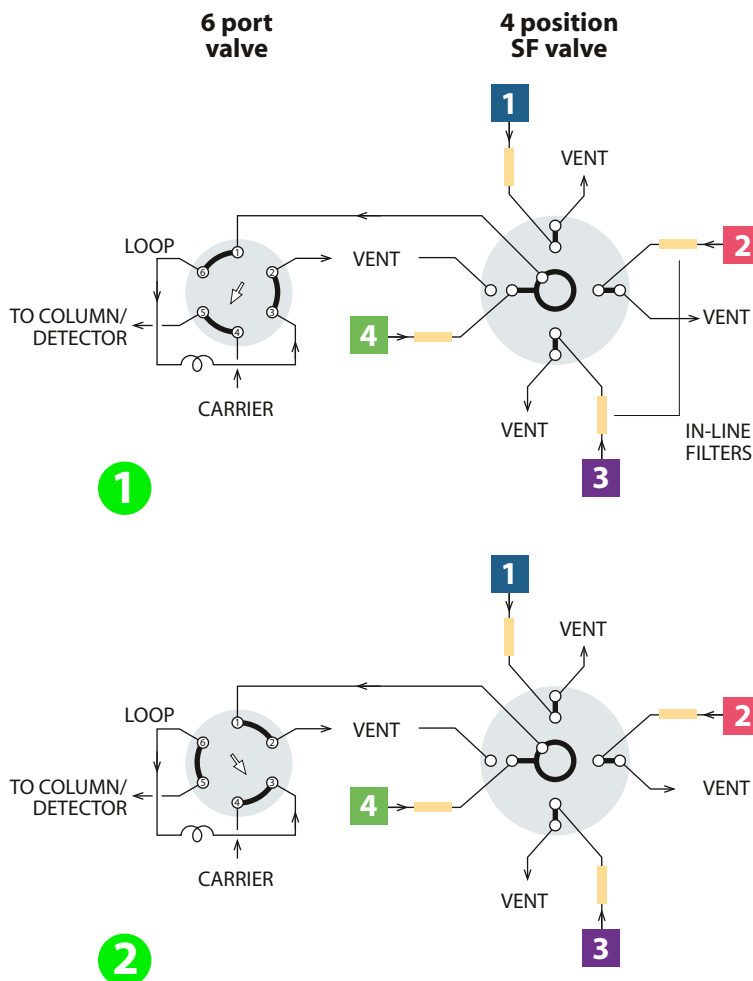

MORE INFORMATION

Actuators
 Air page 196
 Mod.universal 194
 Universal 193

SF prices 128-129

ST flowpath — low pressure

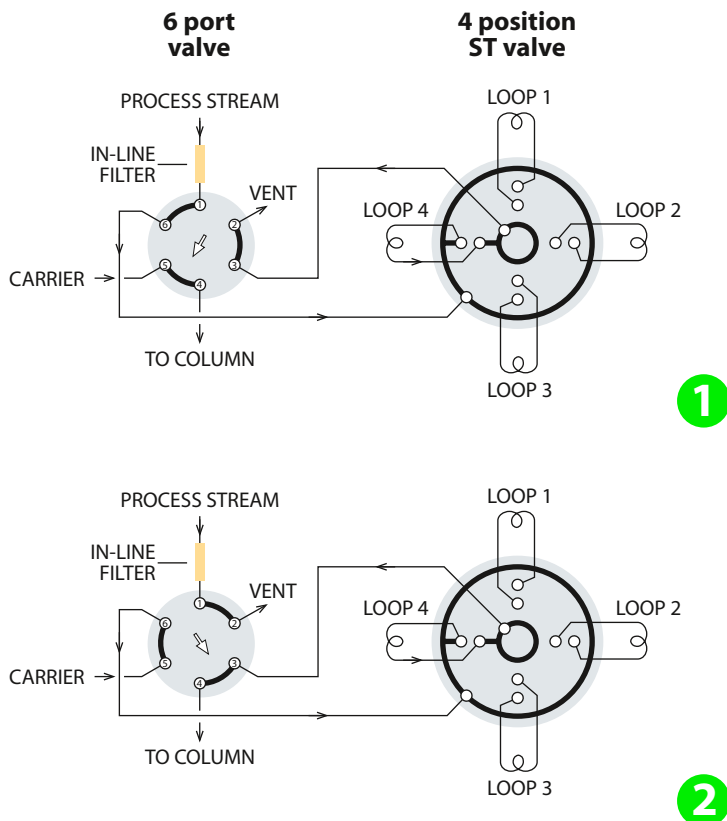

SAMPLE TRAPPING APPLICATIONS FOR 4 TO 16 STREAMS

ST selectors are used for multi-column, multi-sample, or multi-trap operations. The ST configuration is available in both MW and UW type designs.

A typical application, shown here, is the collection of fractions at timed intervals for analysis at a later time. Valves can be ordered with matched loops already installed.

In this example, the 6 port valve shown is used to select between **1** collection/trapping and **2** analysis/desorption. Both valves can be supplied with pneumatic or electric actuators to automate these functions.

TECH TIP

Because the most common cause of valve failure is stray particulates entering the valve, we strongly recommend the use of in-line filters at sample entry points.

Our ZUFR filters feature inexpensive and easily replaceable low pressure drop filter screens (2 or 10 micron). The filters are available in 1/16", 1/8", and 1/4" standard, reducing, and bulkhead versions.

Filters pages 50-52

MORE INFORMATION

ST prices

Low pressure . . 130-131

High pressure135

Application

High pressure ST . . .141

STF flowpath

SAMPLE TRAPPING WITH CONTINUOUS FLOW TO INDIVIDUAL OUTLETS

The STF selector is a variation of the ST flowpath, with the single difference that the non-selected streams are returned to their own vents or sources rather than being dead-ended or trapped as they are in the standard ST configuration. This is ideal for reactor processes in which removal of substantial amounts of sample would upset the equilibrium within the reactor, or if the stream is toxic or noxious and must be isolated.

An STF selector on an air or electric actuator along with a similarly equipped 6 port valve comprise a complete sampling system for the automated analysis of up to 16 sampling points.

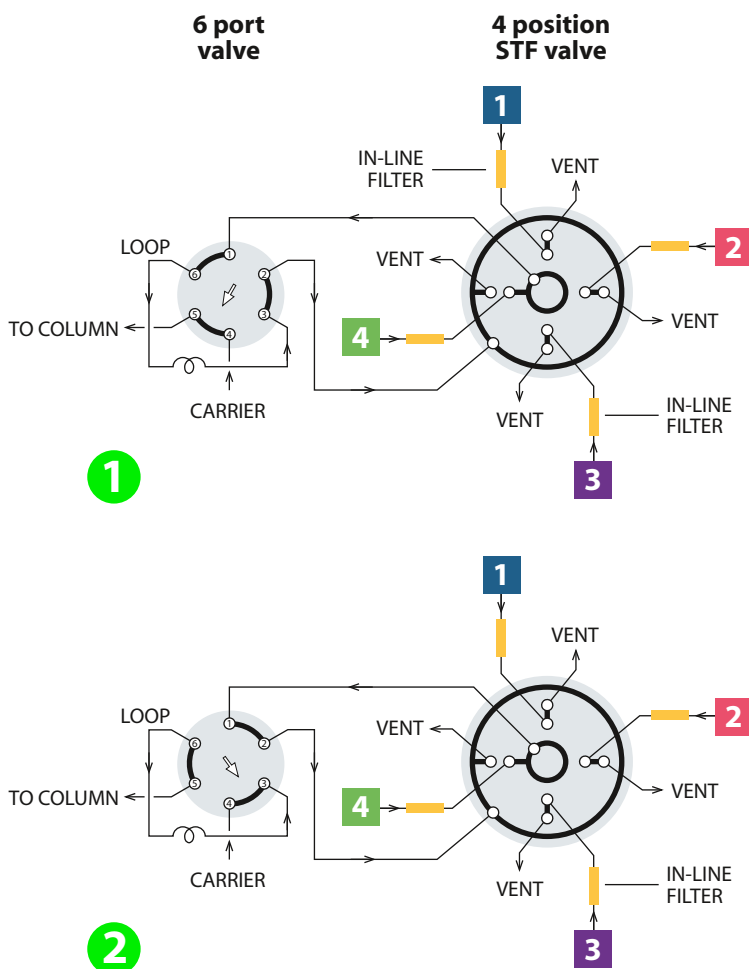

TECH TIP

Because the most common cause of valve failure is stray particulates entering the valve, we strongly recommend the use of in-line filters at sample entry points.

Our ZUFER filters feature inexpensive and easily replaceable low pressure drop filter screens (2 or 10 micron).

The filters are available in 1/16", 1/8", and 1/4" standard, reducing, and bulkhead versions.

MORE INFORMATION

Actuators
 Air page 196
 Mod. universal 194
 Universal 193

STF prices 132-133

Filters pages 50-52

SD flowpath — high pressure

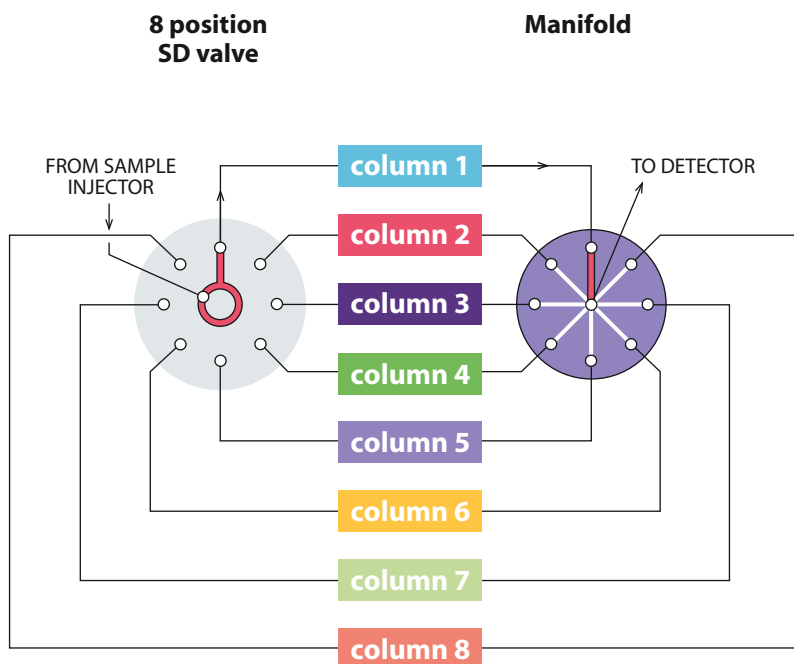
**HPLC COLUMN SELECTION FOR UP TO 10 COLUMNS**

This example illustrates an SD (UW type) selector used for HPLC column selection. This allows multiple columns to be installed permanently in the system, eliminating instrument downtime and leakage potential resulting from having to change columns repeatedly. The SDUW valve selects only column inlets – the column outlets are connected to the detector via a low-volume manifold. The manifold is sold separately.

ST flowpath — high pressure

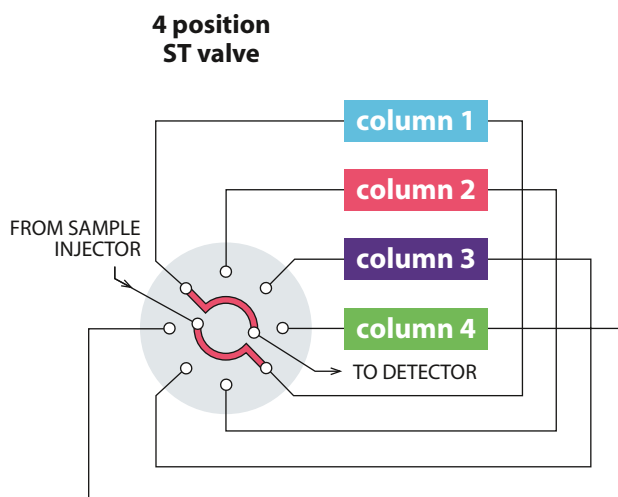
**HPLC COLUMN SELECTION FOR 4 OR 6 COLUMNS**

Up to 6 HPLC columns can be rapidly accessed by column selection valves, eliminating the instrument downtime involved in exchanging columns and the leakage due to repeated changing of tubing fittings. The columns are installed as a part of the loop system, as shown in this drawing. A 6 position valve can support 6 columns.

MORE INFORMATION

Prices

SD high pressure ... 134

ST high pressure ... 135

Application

Low pressure SD ... 136

Low pressure ST ... 139

Manifolds 33